



# Poleas y Tensores SET de Distribución KIT de Distribución



2007/2008



# Tipos de tensores y poleas

## Circuito Primario (Distribución)

Tensores para los sistemas de accionamiento por banda dentada

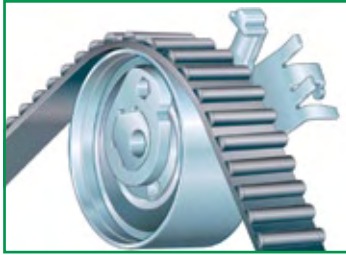

A) Tensor de distribución



B) Tensor con mecanismo de ajuste excéntrico doble



C) Tensor con mecanismo de ajuste excéntrico sencillo

## Circuito Secundario (Accesorio)

Tensores para los sistemas de accionamiento por banda Poly-V



A) Tensores de brazo largo



B) Tensores de brazo corto



C) Tensores cónicos



D) Tensores con sistema hidráulico de amortiguamiento

## Poleas Guía



A) Polea con rodamiento de bolas sencillo



B) Polea con rodamiento de bolas doble

# ÍNDICE

SIMBOLOGÍA	3
------------	---

## APLICACIONES POR MARCAS

ALFA ROMEO	4
AUDI	4
BMW	5
CADILLAC	8
CHRYSLER / DODGE	8
FIAT	14
FORD	14
CHEVROLET	22
HONDA	28
HUMMER	29
INFINITI	29
JAGUAR	29
JEEP	29
LINCOLN	30
MERCEDES BENZ	31
MINI	33
NISSAN	33
PEUGEOT	35
PONTIAC	36
PORSCHE	37
RENAULT	37
SEAT	37
TOYOTA	38
VOLKSWAGEN	39
VOLVO	43

## KITS Y SETS

AUDI	45
CHRYSLER/DODGE	45
FIAT	46
FORD	46
CHEVROLET	47
HONDA	47
INFINITY	47
NISSAN	47
PEUGEOT	48
RENAULT	48



SEAT	49
VOLKSWAGEN	49
VOLVO	50

## **APLICACIONES POR No. DE PARTE**

LISTADO DE APLICACIONES POR No. DE PARTE	52
--	----

## **IMÁGENES**

SECCION DE IMÁGENES	85
---------------------	----

## **REFERENCIAS**

INTERCAMBIOS	111
ESPECIFICACIONES	128

# SIMBOLOGÍA

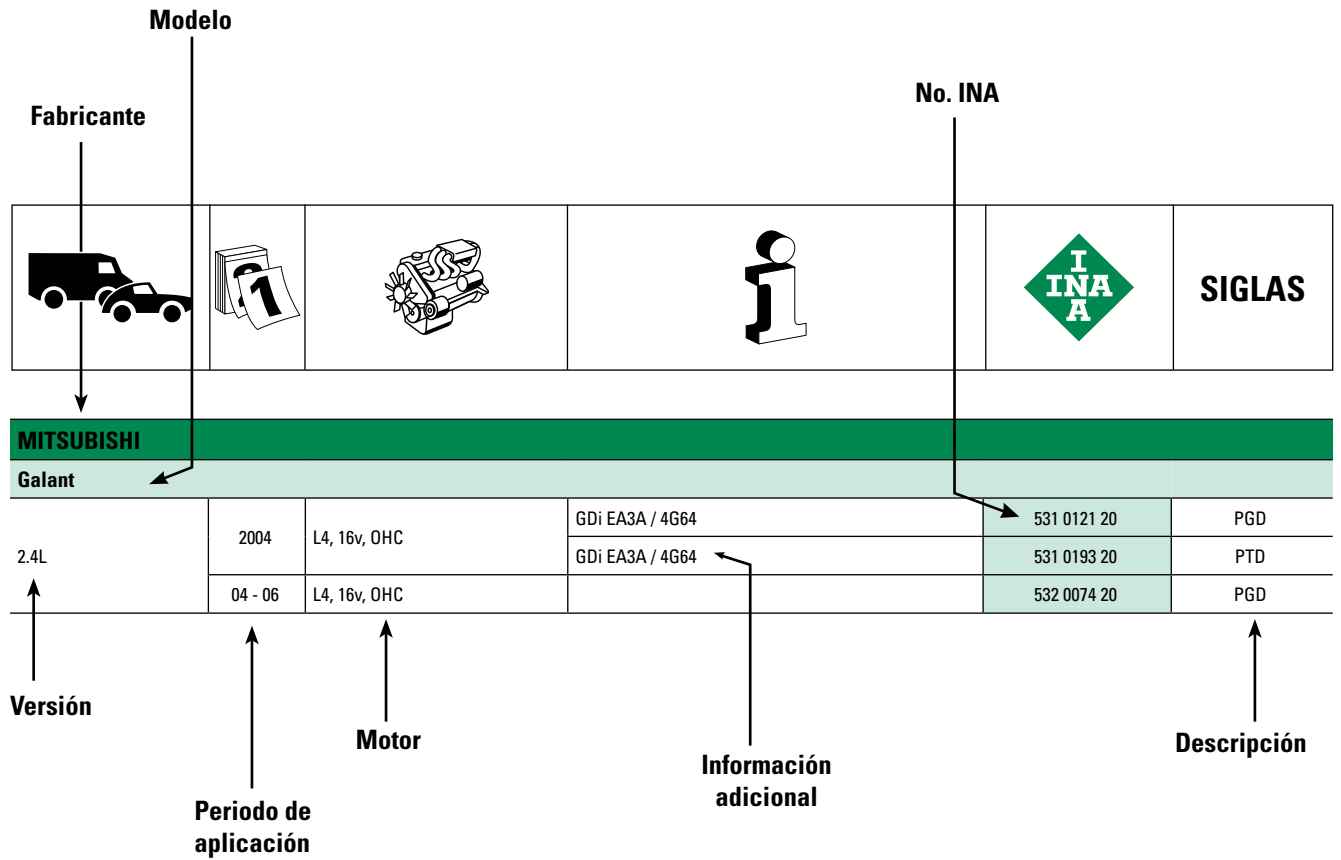

<b>PGA</b>	Polea Guía Accesorios
<b>PGD</b>	Polea Guía de Distribución
<b>PGL</b>	Polea de Giro Libre
<b>PTA</b>	Polea Tensora de Accesorios
<b>PTD</b>	Polea Tensora de Distribución
<b>PTHA</b>	Polea Tensora Hidraulico de Accesorios
<b>THA</b>	Tensor Hidráulico de Accesorios
<b>THB</b>	Tensro Hidráulico de Bandas



## APLICACIONES POR MARCAS

					<b>SIGLAS</b>
--	--	--	--	--	---------------

### ALFA ROMEO

#### 147

2.0L	02 - 05	L4, 16v, (150 HP), DOHC		532 0120 10	PGD
------	---------	-------------------------	--	-------------	-----

#### 156

2.0L	02 - 04	L4, 16v, (150 HP), DOHC		532 0120 10	PGD
------	---------	-------------------------	--	-------------	-----

2.5L	2002	L4, 16v, DOHC		532 0373 20	PGD
------	------	---------------	--	-------------	-----

### AUDI

#### A3

1.8L Turbo	98 - 01	L4, 20v, DOHC		531 0288 30	PTA
				531 0500 20	PTD
	98 - 04	L4, 20v, DOHC		532 0603 20	PGA
				533 0030 20	THA
2.0L	05 - 06	L4, 16v, DOHC		532 0494 10	PGA
				533 0030 20	THA

#### A4

1.8 Turbo	98 - 05	L4, 20v, DOHC		531 0292 30	PTA
	98 - 01			531 0333 20	PTD
	00 - 02			531 0531 20	PTD
	98 - 01			532 0161 10	PGD
	00 - 02			532 0312 20	PGD
	98 - 06			534 0127 30	PTA
2.8L	97 - 01	V6, 30v, (193 HP), DOHC		531 0490 30	PTA
	96 - 01		AGA, AGJ,ACK	532 0159 10	PGD

#### A6

2.7L	00 - 05	V6, 30v, DOHC		531 0490 30	PTA
2.8L	98 - 01	V6, 30v, DOHC		531 0490 30	PTA
Avant 4.2L	01 - 06	V8, 40v, DOHC	4B, C5, 4D2, 4D8	531 0380 10	PTD
4.2L	01 - 06	V8, 40v, DOHC	4B, C5, 4D2, 4D8	531 0380 10	PTD
	01 - 05	V8, 40v, DOHC		532 0066 10	PGA



#### A8

3.7L	00 - 01	V8, 40v, DOHC		532 0066 10	PGA
4.2L	97 - 99	V8, 32v, DOHC	4D2, 4D8	531 0380 10	PTD
	97 -	V8, 40v, DOHC		532 0066 10	PGA
4.2L QUATTRO	99 - 01	V8, 32v, DOHC		532 0066 10	PGA

#### Cabriolet

2.8L	97 - 98	V6, 24v, DOHC		531 0490 30	PTA
------	---------	---------------	--	-------------	-----

## APLICACIONES POR MARCAS

					<b>SIGLAS</b>
---	---	---	---	---	---------------

AUDI					
RS6					
4.2L	2004	V8, 40v, DOHC		532 0066 10	PGA
S3					
1.8L Turbo	2000	L4, 20v, DOHC		531 0500 20	PTD
	00 - 04			533 0030 20	THA
S4					
2.7L	00 - 01	V6, 30v, DOHC		531 0490 30	PTA
S6					
4.2L	01 - 04	V8, 40v, DOHC		532 0066 10	PGA
S8					
Avant 4.2L	01 - 06	V8, 40v, DOHC	4B, C5, 4D2, 4D8	531 0380 10	PTD
4.2L	01 - 06	V8, 40v, DOHC		531 0380 10	PTD
	01 - 02	V8, 40v, DOHC		532 0066 10	PGA
TT					
1.8L. Turbo	99 - 00	L4, 20v, (150 HP), DOHC		531 0500 20	PTD
1.8L. Turbo QUATTRO	99 - 06	L4, 20v, DOHC		532 0494 10	PGA
	99 - 03	L4, 20v, DOHC		533 0030 20	THA
	99 - 06	L4, 20v, DOHC	Alternador BOSCH 70A/90A	535 0012 10	PGL
BMW					
Serie 3					
323ci	97 - 01	L6, 24v, 2.5L, DOHC		533 0015 10	PTA
323i	97 - 01	L6, 24v, 2.5L, DOHC	Aire Acondicionado	531 0346 10	PTA
			Alternador / Bomba agua / Dir. Hidráulica	532 0001 10	PGA
			Aire Acondicionado	533 0001 10	THA
				533 0015 10	PTA
				534 0008 10	PTHA
				534 0009 10	PTHA
323is	97 - 01	L6, 24v, 2.5L, DOHC		533 0015 10	PTA
325ci	95 - 06	L6, 24v, 2.5L, DOHC	Aire Acondicionado	532 0494 10	PGA
325i	02 - 04	L6, 24v, (170 - 190 HP), 2.5L, DOHC	Aire Acondicionado	531 0346 10	PTA
			Alternador / Bomba agua / Dir. Hidráulica	532 0001 10	PGA
			Aire Acondicionado	533 0001 10	THA
				532 0059 10	PGA
				533 0015 10	PTA
				532 0494 10	PGA
	95 - 06		Aire Acondicionado	532 0494 10	PGA



## APLICACIONES POR MARCAS

					<b>SIGLAS</b>
--	--	--	--	--	---------------

### BMW

#### Serie 3





325i	95 - 01	L6, 24v, (170 - 190 HP), 2.5L, DOHC		534 0008 10	PTHA
				534 0009 10	PTHA
325is	95 - 06	L6, 24v, (170 - 190 HP), 2.5L, DOHC		533 0015 10	PTA
325xi	95 - 06	L6, 24v, (170 - 190 HP), 2.5L, DOHC		532 0494 10	PGA
			Aire Acondicionado	533 0015 10	PTA
328ci	96 - 00	L6, 24v, 2.8L, DOHC		533 0015 10	PTA
328i	97 - 98	L6, 24v, 2.8L, DOHC	Aire Acondicionado	531 0346 10	PTA
			Alternador / Bomba de agua / Dir. Hidráulica	532 0001 10	PGA
			Alternador / Bomba de agua / Dir. Hidráulica	533 0003 10	THA
			533 0015 10	PTA	
	96 - 00			534 0008 10	PTHA
				534 0009 10	PTHA
328is	96 - 00	L6, 24v, 2.8L, DOHC		533 0015 10	PTA
330ci	01 - 06	L6, 24v, 3.0L, DOHC	Aire Acondicionado	532 0494 10	PGA
				533 0015 10	PTA
330i	01 - 04	L6, 24v, 3.0L, DOHC	Aire Acondicionado	531 0346 10	PTA
			Alternador / Bomba de agua / Dir. Hidráulica	532 0001 10	PGA
	01 - 06		Aire Acondicionado	532 0494 10	PGA
			Alternador / Bomba de agua / Dir. Hidráulica	533 0003 10	THA
	01 - 04			533 0015 10	PTA
				534 0008 10	PTHA
330xi	01 - 06	L6, 24v, 3.0L, DOHC	Aire Acondicionado	532 0494 10	PGA
				533 0015 10	PTA
M3	02 - 03	L6, 24v, 3.2L, DOHC	Alternador / Bomba de agua / Dir. Hidráulica	531 0003 10	PTA
	00 - 03		Aire Acondicionado	531 0346 10	PTA
	00 - 03		Alternador / Bomba de agua / Dir. Hidráulica	532 0001 10	PGA
	96 - 04		Aire Acondicionado	532 0494 10	PGA
	02 - 03		Alternador / Bomba de agua / Dir. Hidráulica	533 0003 10	THA
	2001			533 0015 10	PTA
	00 - 03			534 0008 10	PTHA
	00 - 03			534 0009 10	PTHA

#### Serie 5

525i	01 - 03	L6, 24v, 2.5L, DOHC		531 0322 10	PTA
			532 0059 10	PGA	
	01 - 06		Aire Acondicionado	532 0494 10	PGA
	01 - 03			533 0007 10	THA



## APLICACIONES POR MARCAS

					<b>SIGLAS</b>
---	---	---	---	---	---------------

### BMW

#### Serie 5

525i	01 - 06	L6, 24v, 2.8L, DOHC	Aire Acondicionado	533 0015 10	PTA
528i	96 - 00	L6, 24v, 2.8L, DOHC	Aire Acondicionado	531 0346 10	PTA
	96 - 01		Alternador / Bomba de agua / Dir. Hidráulica	532 0001 10	PGA
	96 - 00		Aire Acondicionado	533 0001 10	THA
				533 0015 10	PTA
				534 0008 10	PTHA
	96 - 01		534 0009 10	PTHA	
530i	02 - 06	L6, 24v, (228 HP) 3.0L, DOHC	Aire Acondicionado	532 0494 10	PGA
	00 - 06			533 0015 10	PTA
	95 - 96			533 0015 10	PTA
540i	97 - 03	V8, 32v, 4.4L, DOHC		531 0267 10	PTA
	97 - 00		Alternador / Bomba de agua / Dir. Hidráulica	533 0013 10	THA
			Aire Acondicionado	533 0014 10	THA
				534 0003 10	PTHA
				534 0004 10	PTHA
M5	2006	V10, 24v, 3.2L, DOHC	Aire Acondicionado	533 0014 10	THA
				534 0003 10	PTHA

#### Serie 7

740i	01 - 01	V8, 32v, 4.4L, DOHC		531 0267 10	PTA
	98 - 00		Alternador / Bomba de agua / Dir. Hidráulica	533 0013 10	THA
			Aire Acondicionado	533 0014 10	THA
				534 0003 10	PTHA
				534 0004 10	PTHA
750i	95 - 01	V12, 48v, 5.4L, DOHC	Aire Acondicionado / Fan	531 0004 10	PTA

#### Serie Z

Z3	96 - 99	L4, 16v, (140 HP), 1.9 L, DOHC	Aire Acondicionado	531 0095 10	PGA
				533 0001 10	THA
	2000	L4, 24v, (150 HP), 2.0L, DOHC	Alternador / Bomba de agua / Dir. Hidráulica	531 0003 10	PTA
				533 0015 10	THA
	97 - 00	L6, 24v, (192 HP), 2.8L, DOHC		533 0015 10	PTA
	01 - 02	L6, 24v, (228 HP), 3.0L, DOHC	Aire Acondicionado	531 0346 10	PTA
			Alternador / Bomba de agua / Dir. Hidráulica	532 0001 10	PGA
	00 - 02	L6, 24v, (317, 321 HP), 3.2L, DOHC	Aire Acondicionado	532 0494 10	PGA
				533 0015 10	PTA
	Z4	03 -	L6, 24v, 2.5L, DOHC	Aire Acondicionado	532 0494 10
				533 0015 10	PTA
03 -		L6, 24v, 3.0L, DOHC	Aire Acondicionado	532 0494 10	PGA
				533 0015 10	PTA



## APLICACIONES POR MARCAS

					<b>SIGLAS</b>
--	--	--	--	--	---------------

### CAMIONETA (SUV)

#### Serie X

X3	04 -	L6, 24v, 2.5L, DOHC	Aire Acondicionado	532 0494 10	PGA
				533 0015 10	PTA
		L6, 24v, 3.0L, DOHC	Aire Acondicionado	532 0494 10	PGA
				533 0015 10	PTA
X5	01 -	L6, 24v, 3.0L, DOHC	Aire Acondicionado	532 0494 10	PGA
				533 0015 10	PTA
	00 - 06	V8, 24v, 4.4L, DOHC	Aire Acondicionado	532 0494 10	PGA

### CADILLAC

#### Catera

3.0L	97 - 01	V6, 24v, DOHC		531 0560 00	PTA
------	---------	---------------	--	-------------	-----

#### CTS

3.2L	2003	V6, 24v, (220 HP), DOHC		531 0560 00	PTA
------	------	-------------------------	--	-------------	-----

#### Deville

4.6L	95 - 04	V8, 32v, DOHC		532 0265 20	PGA
			Con buje de 10mm.	532 0487 10	PGA
				534 0228 10	PTA
				534 0237 10	PTA
4.9L	91 - 95	V8, 16v, OHV		531 0445 20	PTA
	94 - 95			531 0794 10	PGD

#### Eldorado

4.6L	93 - 97	V8, 32v, DOHC		534 0228 10	PTA
	95 - 97			534 0237 10	PTA

#### Escalade

5.3L	02 - 05	V8, 16v, OHV	Aire Acondicionado	534 0226 10	PTA
				534 0236 10	PTA
6.0L	02 - 05	V8, 16v, OHV		534 0226 10	PTA
				534 0236 10	PTA

#### Seville



4.6L	95 - 04	V8, 32v, DOHC		534 0228 10	PTA
				534 0237 10	PTA
4.9L	1994	V8, 16v, OHV		531 0445 20	PTA

### CHRYSLER / DODGE

#### 300

3.5L	06 -	V6, 24v, OHV		534 0217 10	PTA
5.7L	05 -	V8, 16v, OHV		534 0217 10	PTA

## APLICACIONES POR MARCAS

					<b>SIGLAS</b>
---	---	---	---	---	---------------

### CHRYSLER / DODGE

#### 300M

3.5L	98 - 04	V6, 24v, OHC	Aire Acondicionado	532 0285 20	PGA
			Con buje de 10mm.	532 0487 10	PGA

#### Atos

1.0L	01 - 04	L4, 12v, OHC		531 0585 20	PTD
1.1L	05 -	L4, 12v, OHC		531 0585 20	PTD

#### Breeze

2.0L	1996	L4, 16v, (150 HP), DOHC	Con buje de 10mm.	532 0487 10	PGA
2.4L	1996	L4, 16v, (150 HP), DOHC		531 0567 00	PTD
			Con buje de 10mm.	532 0487 10	PGA

#### Cirrus

2.4L Turbo	97 - 01	L4, 16v, DOHC		531 0371 10	PTD
				531 0567 00	PTD
	97 - 01		Con buje de 10mm.	532 0487 10	PGA
	02 - 06			532 0498 10	PGA
2.4L	97 - 00			532 0227 10	PGD
2.5L	96 - 00	L4, 16v, OHC		532 0265 20	PGA
	96 - 00	V6, 24v, OHV		532 0487 10	PGA

#### Concorde

3.2L	2001	V6, 24v, OHC	Aire Acondicionado	532 0285 20	PGA
			Con buje de 10mm.	532 0487 10	PGA
3.5L	95 - 97	V6, 24v, OHC		531 0370 10	PTD
				532 0261 20	PGA
			Con buje de 12mm.	532 0261 10	PGA
				532 0265 20	PGA
				532 0285 20	PGA
			95 - 02	Con buje de 10mm.	532 0487 10

#### Crossfire

3.2L	04 - 06	V6, 18v, OHC		531 0487 30	PTA
------	---------	--------------	--	-------------	-----

#### Dart K

2.2L	82 - 89	L4, 8v, OHC		531 0326 10	PTD
			Con buje de 12mm, Aire Acondicionado	532 0261 10	PGA

#### Intrepid

2.7L	1998	V6, 24v, DOHC		532 0263 20	PGA
3.5L	95 - 97	V6, 24v, OHC		531 0370 10	PTD
				532 0285 20	PGA



## APLICACIONES POR MARCAS

					<b>SIGLAS</b>
--	--	--	--	--	---------------

### CHRYSLER / DODGE

Lebaron					
K 2.2L	83 - 87	L4, 8v, OHC	Con buje de 12mm, Aire Acondicionado	532 0261 10	PGA
	82 - 88			531 0326 10	PTD
				531 0364 10	PTD
K 2.5L	92 - 95	L4, 8v, OHC	Con buje de 12mm, Aire Acondicionado	532 0261 10	PGA
				532 0261 20	PGA
				532 0265 20	PGA
LHS 3.5L	96 - 97	V6, 24v, OHC	Aire Acondicionado	532 0285 20	PGA
			Con buje de 10mm. Alternador, Dir. Hidráulica	532 0487 10	PGA
				531 0370 10	PTD

Magnum K					
5.7L Turbo	83 - 88	L4, 8v, OHC		531 0364 10	PTD
5.7L	83 - 88	L4, 8v, OHC	Aire Acondicionado, con buje de 12mm.	532 0261 10	PGA

Neon					
2.0L	95 - 99	L4, 16v, DOHC		531 0371 10	PTD
	99 - 05	L4, 16v, OHC	Con base de aluminio	532 0227 10	PGD
			531 0566 40	PTD	
2.4L	04 - 05			531 0371 10	PTD
	99 - 05		Con base de aluminio	531 0566 40	PTD



New Yorker					
2.2L	85 - 91	L4, 8v, OHC		531 0326 10	PTD
	92 - 94		Con buje de 12mm.	532 0261 20	PGA
2.5L	92 - 94	L4, 8v, OHC	Con buje de 12mm.	532 0261 20	PGA
				532 0265 20	PGA
LHS 3.5L	1995	V6, 24v, OHC	Aire Acondicionado	532 0285 20	PGA
			Con buje de 10mm.	532 0487 10	PGA

Phantom					
2.2L Turbo	97 - 89	L4, 8v, OHC		534 0217 10	PTA
2.5L	90 - 94	L4, 8v, OHC		531 0326 10	PTD

PT cruiser					
2.4L	01 -	L4, 16v, DOHC	Con base de aluminio	531 0566 40	PTD
			Aire Acondicionado, Dir. Hidráulica	531 0568 00	PTA
				531 2201 10	PTHA
				532 0304 10	PGA

Shadow					
2.2L	89 - 90	L4, 8v, OHC		532 0261 20	PGA
2.2L Turbo	89 - 90	L4, 8v, OHC		531 0364 10	PTD
	90 - 90		Con buje de 12mm, Aire Acondicionado	532 0261 10	PGA

## APLICACIONES POR MARCAS

					<b>SIGLAS</b>
---	---	---	---	---	---------------

### CHRYSLER / DODGE

#### Shadow

2.5L	91 - 94	L4, 8v, OHC	Con buje de 12mm, Aire Acondicionado	532 0261 10	PGA
				532 0261 20	PGA

#### Spirit

2.5L	90 - 95	L4, 8v, OHC	Con buje de 12mm.	532 0261 20	PGA
------	---------	-------------	-------------------	-------------	-----

#### Stratus

2.4L	02 - 04	L4, 16v, DOHC	Con base de aluminio	531 0566 40	PTD
	2002			531 0567 00	PTD
	95 - 00		Con buje de 10mm.	532 0227 10	PGD
	95 - 02			532 0487 10	PGA
2.4L Turbo	95 - 01	L4, 16v, DOHC		532 0498 10	PGA
				531 0371 10	PTD

#### Verna

1.6L	04 - 06	L4, 16v, DOHC		531 0118 20	PTD
------	---------	---------------	--	-------------	-----

#### Volare K

2.2L	82 - 88	L4, 8v, OHC		531 0326 10	PTD
------	---------	-------------	--	-------------	-----

### CAMIONETA (PICK-UP/SUV/VAN/MINIVAN/CROSSOVER)

#### Caravan

3.3L	2002	V6, 12v, OHV		532 0266 20	PGA
	90 - 00		Con buje de 10mm.	532 0487 10	PGA
	01 - 03		Con buje de 10mm.	532 0493 10	PGA
	01 - 05			532 0494 10	PGA
	90 - 00		Con buje de 12mm, Aire Acondicionado	532 0495 10	PGA
	01 - 04			534 0209 10	PTA
3.8L	96 - 00	V6, 12v, OHV	Con buje de 10mm.	532 0487 10	PGA
	96 - 00		Con buje de 12mm, Aire Acondicionado	532 0495 10	PGA

#### D 150

3.7L	83 - 92	L6, 12v, OHV	Con buje de 12mm, Aire Acondicionado	532 0261 10	PGA
3.9L	92 - 93	V6, 12v, OHV		531 0430 10	PGA
				531 0793 10	PGA

#### Dakota

2.5L	1996	L4, 8v, OHC	Con buje de 12mm, Aire Acondicionado	532 0261 10	PGA
			Con buje de 10mm, Mecanismo autoajustable	532 0487 10	PGA
			Con buje de 10mm, Mecanismo fijo	532 0493 10	PGA
3.7L	05 -	V6, 12v, OHC	Con buje de 10mm.	532 0487 10	PGA
				534 0197 10	PTA
4.7L	2007	V8, 16v, OHV	Con buje de 10mm.	532 0487 10	PGA
				534 0197 10	PTA



## APLICACIONES POR MARCAS

					<b>SIGLAS</b>
--	--	--	--	--	---------------

### CHRYSLER / DODGE

#### CAMIONETA (PICK-UP/SUV/VAN/MINIVAN/CROSSOVER)

##### Durango

4.7L	01 -	V8, 16v, OHC	Con buje de 10mm.	532 0487 10	PGA
				534 0197 10	PTA
5.2L	98 -00	V8, 16v, OHV		531 0430 10	PGA
				531 0793 10	PGA
5.9L	99 - 03	V8, 16v, OHV		531 0430 10	PGA
				531 0430 20	PTA
				531 0793 10	PGA

##### H 100

2.4L	03 - 05	L4, 8v, OHC		531 0123 20	PTD
------	---------	-------------	--	-------------	-----

##### Grand Caravan

3.3L	90 - 00	V6, 12v, OHV	Con buje de 10mm.	532 0487 10	PGA
			Con buje de 12mm.	532 0495 10	PGA
	01 - 03		Con buje de 10mm.	532 0493 10	PGA
	01 - 05			532 0494 10	PGA
				534 0209 10	PTA
3.8L	94 - 00	V6, 12v, OHV	Con buje de 10mm.	532 0487 10	PGA
			Con buje de 12mm, Aire Acondicionado	532 0495 10	PGA
	01 - 02			532 0266 20	PGA
			Con buje de 10mm.	532 0493 10	PGA
	01 - 04			534 0209 10	PTA
			01 - 05		532 0494 10

##### Grand Voyager

3.8L	93 - 00	V6, 12v, OHV		531 0429 20	PTA
	95 - 00			532 0266 20	PGA
3.8L	95 - 02	V6, 12v, OHV	Con buje de 10mm.	532 0487 10	PGA
			Con buje de 12mm.	532 0495 10	PGA





##### Pacifica

3.5L	04 - 06	V6, 24v, OHV		534 0217 10	PTA
------	---------	--------------	--	-------------	-----

##### Ram 1500

3.7L	03 - 06	V6, 12v, OHC	Con buje de 10mm.	532 0487 10	PGA
				534 0197 10	PTA
3.9L	94 - 02	V6, 12v, OHV		531 0430 10	PGA
				531 0430 20	PTA
				531 0793 10	PGA
				532 0272 20	PGA

## APLICACIONES POR MARCAS

					<b>SIGLAS</b>
---	---	---	---	---	---------------

### CHRYSLER / DODGE

#### CAMIONETA (PICK-UP/SUV/VAN/MINIVAN/CROSSOVER)

##### Ram 1500

Van 3.9L	95 - 03	V6, 12v, OHV		531 0430 10	PGA
				531 0793 10	PGA
				532 0272 20	PGA
Wagon 3.9L	95 - 03	V6, 12v, OHV		532 0272 20	PGA

##### Ram 2500

4.7L	02 - 06	V8, 16v, OHV	Con buje de 10mm.	532 0487 10	PGA
				534 0197 10	PTA
5.2L	97 - 02	V8, 16v, OHV		531 0430 10	PGA
	96 - 02			532 0272 20	PGA
Van 5.2L	96 - 02	V8, 16v, OHV		531 0430 10	PGA
				531 0793 10	PGA
				532 0272 20	PGA
Wagon 5.2L	95 - 02	V8, 16v, OHV		532 0272 20	PGA
5.7L	1994	V8, 16v, (230 HP), OHV		532 0272 20	PGA
5.9L	95 - 02	V8, 16v, OHV		531 0430 10	PGA
				531 0793 10	PGA
Van 5.9L	97 - 02	V8, 16v, OHV	Con buje de 12mm.	532 0261 10	PGA
8.0L	96 - 97	V10, 20v, OHV		531 0430 10	PGA

##### Ram 3500

5.9L	95 - 02	V8, 16v, OHC		532 0272 20	PGA
Maxi Wagon 5.2L	95 - 02	V8, 16v, OHV		532 0272 20	PGA
Maxi Wagon 5.9L	95-02	V8, 16v, OHV		531 0430 20	PTA
		V8, 16v, OHV		532 0272 20	PGA
Van 5.9L	97 - 02	V8, 16v, OHC		532 0272 20	PGA

##### Ram 4000

5.7L	05 - 06	V8, 16v, OHC		532 0272 20	PGA
5.9L	2002	V8, 16v, OHV		531 0430 20	PTA
				532 0272 20	PGA

##### Ram Charger

5.2L	99 - 01	V8, 16v, OHV		532 0272 20	PGA
5.9L	1994			531 0430 10	PGA
				531 0793 10	PGA
			Con buje de 12mm, Aire Acondicionado	532 0261 10	PGA
	86 - 89	V8, 16v, OHV		532 0272 20	PGA
	86 - 01			532 0272 20	PGA
	90 - 94			532 0499 10	PGA



## APLICACIONES POR MARCAS

					<b>SIGLAS</b>
--	--	--	--	--	---------------

### CHRYSLER / DODGE

#### CAMIONETA (PICK-UP/SUV/VAN/MINIVAN/CROSSOVER)

##### Town & Country

3.8L	93 - 00	V6, 12v, OHV		531 0429 20	PTA
	02 -			532 0266 20	PGA
	95 - 01		Con buje de 10mm.	532 0487 10	PGA
	02 -		Con buje de 10mm.	532 0493 10	PGA
				532 0494 10	PGA
	95 - 01		Con buje de 12mm, Aire Acondicionado	532 0495 10	PGA
	02 -			534 0209 10	PTA

##### Voyager

3.3L	91 - 00	V6, 12v, OHV		531 0429 20	PTA
				532 0261 20	PGA
				532 0266 20	PGA
	00 - 01		Con buje de 10mm.	532 0487 10	PGA
	95 - 01		Con buje de 10mm.	532 0487 10	PGA
	02 - 04		Con buje de 10mm.	532 0493 10	PGA
				532 0494 10	PGA
	95 - 01		Con buje de 12mm.	532 0495 10	PGA
02 - 04		534 0209 10	PTA		

### FIAT

#### Palio

1.6L	04 - 06	L4, 16v, DOHC		531 0280 10	PTD
				532 0209 10	PGD
1.6L	04 - 06	L4, 16v, DOHC		532 0229 10	PGA





### FORD

#### Contour

2.0L	96 - 98	L4, 16v, DOHC		531 0021 10	PTD
				534 0205 10	PTA
	96 - 00	L4, 16v, DOHC		532 0093 10	PGD
				532 0151 10	PGD
				532 0263 20	PGA
			532 0266 20	PGA	
2.5L	96 - 00	V6, 24v, DOHC		531 0345 10	PTD
				534 0210 10	PTA
				532 0016 10	PGD
			532 0263 20	PGA	

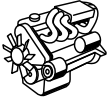

## APLICACIONES POR MARCAS

					<b>SIGLAS</b>
---	---	---	---	---	---------------

<b>FORD</b>					
<b>Cougar</b>					
3.8L	85 - 94	V6, 12v, OHV		531 0434 30	PTA
			Versión XR-7	531 0794 10	PGD
			Versión XR-7	534 0223 10	PTA
			Versión XR-7	534 0222 10	PTA
				532 0265 20	PGA
	85 - 88	V6, 12v, OHC		532 0490 10	PGA
89 - 90	V6, 12v, OHV		531 0794 10	PGD	
		Versión XR-7	534 0221 10	PTA	
4.9L	91 - 95	V8, 12v, OHC		531 0460 20	PTA
				532 0268 20	PGA
<b>Crown Victoria</b>					
5.7L	1981	V8, 16v, OHC		531 0460 20	PTA
<b>Escort</b>					
1.8L	1995	L4, 16v, DOHC		531 0021 10	PTD
				531 0435 30	PTA
1.9L	94 - 96	L4, 8v, OHC		531 0345 10	PTD
				531 0435 30	PTA
				532 0151 10	PGD
				532 0152 10	PGD
2.0L	97 - 01	L4, 16v, DOHC		531 0345 10	PTD
				531 0442 30	PTA
	98 - 01			534 0190 10	PTD
				534 0200 10	PTA
<b>Fairmont</b>					
5.0L	78 - 83	V8, 16v, OHV		532 0488 10	PGA
<b>Fiesta</b>					
1.3L	98 - 01	L4, 8v, OHV		531 0019 10	PTD
				532 0187 10	PGA
				532 0254 10	PGA
1.4L	98 - 00	L4, 16v, DOHC		531 0020 10	PTD
				531 0541 10	PTA
				531 0586 10	PTD
1.6L	01 - 04	L4, 8v, OHC		531 0020 10	PTD
<b>Five Hundred</b>					
3.0L	05 -	V6, 24v, DOHC		534 0225 10	PTA



## APLICACIONES POR MARCAS

					<b>SIGLAS</b>
--	--	--	--	--	---------------

### FORD

#### Focus

2.0L	00 - 02	L4, 16v, DOHC		532 0494 10	PGA
	00 - 03	L4, 16v, DOHC		531 0345 10	PTD
				532 0151 10	PGD
				532 0152 10	PGD
				534 0130 20	PTA
	00 - 06	L4, 16v, DOHC		534 0190 10	PTD
			534 0214 10	PTA	

#### Ghia

3.0L	91 - 94	V6, 12v, OHV		532 0263 20	PGA
				532 0264 20	PGA

#### Grand Marquis

4.6L	92 - 00	V8, 16v, OHC		531 0460 20	PTA
	92 - 04	V8, 16v, OHC		531 0460 20	PTA
				532 0268 20	PGA
	00 - 04	V8, 16v, OHC		531 0799 10	PGA
				534 0211 10	PTA
5.7L	85 - 86	V8, 16v, OHV		532 0490 10	PGA

#### Ikon

1.6L	04 - 06	L4, 8v, OHC		534 0125 30	PTA
------	---------	-------------	--	-------------	-----

#### Ka

1.6L	04 - 06	L4, 8v, OHC		534 0125 30	PTA
------	---------	-------------	--	-------------	-----

#### LTD

5.7L	80 - 81	V8, 16v, OHV		532 0488 10	PGA
------	---------	--------------	--	-------------	-----



#### Mondeo

2.0L	01 - 04	L4, 16v, DOHC		532 0494 10	PGA
		L4, 16v, DOHC		534 0210 10	PTA
	02 - 06	L4, 16v, DOHC		531 0021 10	PTD
2.5L	02 - 04	V6, 24v, DOHC		532 0016 10	PGD
				534 0128 30	PTA

#### Mustang

4.6L	00 - 04	V8, 16v, OHC		531 0799 10	PGA
				534 0211 10	PTA
GT 4.6L	96 - 00	V8, 16v, OHC		532 0276 20	PGA
Cobra 4.6L	96 - 00	V8, 16v, OHC		532 0276 21	PGA
5.0 L	1984	V8, 16v, OHV		532 0488 10	PGA
	94 - 95			534 0208 10	PTA

## APLICACIONES POR MARCAS

					<b>SIGLAS</b>
---	---	---	---	---	---------------

FORD					
Mustang					
GT 5.0L	79 - 94	V8, 16v, OHV		531 0431 30	PTA
Cobra 5.0L	79 - 94	V8, 16v, OHV		531 0431 30	PTA
				531 0433 20	PTA
Mystique					
2.0L	1995	L4, 16v, DOHC		531 0021 10	PTD
				532 0093 10	PGD
				532 0151 10	PGD
				532 0263 20	PGA
				532 0494 10	PGA
2.5L	95 - 00	V6, 24v, DOHC		534 0205 10	PTA
				532 0016 10	PGD
				532 0263 20	PGA
Sable					
3.0L	96 - 97	V6, 24v, DOHC		532 0485 10	PGA
	96 - 00	V6, 24v, DOHC		534 0207 10	PTA
	96 - 04	V6, 24v, DOHC		531 0461 20	PTA
				532 0263 20	PGA
	01 - 05	V6, 24v, DOHC		534 0230 10	PTA
Taurus					
3.8L	98 - 91	V6, 12v, OHC		531 0459 20	PTA
				531 0794 10	PGD
				532 0275 20	PGA
Thunderbird					
3.8L	85 - 88	V6, 12v, OHC		532 0490 10	PGA
	85 - 94	V6, 12v, OHC		531 0434 30	PTA
	89 - 94	V6, 12v, OHC		531 0794 10	PGD
				534 0221 10	PTA
	90 - 94	V6, 16v, OHC		532 0265 20	PGA
				532 0275 20	PGA
Super Cargado 3.8L	89 - 94	V6, 12v, OHC	Con buje de 70mm.	534 0222 10	PTA
			Con buje de 76mm.	534 0223 10	PTA
3.9L	03 - 04	V8, 32v, DOHC		534 0225 10	PTA
4.6L	95 - 96	V8, 16v, OHC		531 0460 20	PTA
5.0L	90 - 94	V8, 16v, OHC		531 0460 20	PTA
		V6, 16v, OHC		532 0268 20	PGA
	91 - 94	V8, 16v, OHC		531 0794 10	PGD



## APLICACIONES POR MARCAS

					<b>SIGLAS</b>
--	--	--	--	--	---------------

### FORD

Topaz					
2.3L	84 - 94	L4, 8v, OHC		532 0262 20	PGA
	88 - 94	L4, 8v, OHC		534 0191 10	PTA
	92 - 94	L4, 8v, OHC	Aire Acondicionado	531 0795 10	PGA

### ZX2

2.0L	2003	L4, 16v, DOHC		534 0200 10	PTA
------	------	---------------	--	-------------	-----

### ZX3

2.0L	03 - 04	L4, 16v, DOHC		534 0200 10	PTA
------	---------	---------------	--	-------------	-----

### CAMIONETA (PICK-UP/SUV/VAN/MINIVAN)

#### Aerostar

3.0L	91 - 93	V6, 12v, OHC		532 0484 10	PGD
4.0L	94 - 95	V6, 16v, OHV		532 0262 20	PGA
		V6, 12v, OHV		534 0194 10	PTA
		V6, 12v, OHV		532 0484 10	PGD





#### Bronco

4.6L	93 - 95	V8, 16v, OHC		532 0278 20	PGA
				534 0193 10	PTA
5.0L	91 - 96	V8, 16v, OHC		531 0794 10	PGD
	93 - 95			532 0278 20	PGA
5.4L	93 - 95	V8, 16v, OHC		532 0278 20	PGA
5.8L	91 - 96	V8, 16v, OHC		531 0794 10	PGD
	93 - 95			532 0278 20	PGA

#### Econoline

E-150 4.2L	97 - 03	V6, 12v, OHV		531 0443 30	PTA
				532 0268 20	PGA
				532 0275 20	PGA
E-250 4.2L	97 - 98	V6, 12v, OHV		531 0444 30	PTA
E-350 5.4L	98 - 99	V8, 16v, OHC		531 0444 30	PTA
Van 4.2L	97 - 03	V6, 12v, OHV		531 0794 10	PGD
Van 4.6L	04 - 06	V8, 16v, OHV		534 0212 10	PTA
				534 0220 10	PTA
Van 4.9L	95 - 96	L6, 12v, OHV		532 0486 10	PGA
				534 0193 10	PTA
Van 5.4L	98 - 01	V8, 16v, OHC		531 0797 10	PGD
	97 - 03			532 0486 10	PGA
	98 - 01			534 0218 10	PTA

## APLICACIONES POR MARCAS

					<b>SIGLAS</b>
---	---	---	---	---	---------------

### FORD

#### CAMIONETA (PICK-UP/SUV/VAN/MINIVAN)

##### Econoline

Van 6.8L	97 - 01	V10, 20v, OHC		531 0797 10	PGD
				532 0486 10	PGA
				534 0218 10	PTA
Wagon 5.4L	99 - 05	V8, 16v, OHC		532 0275 20	PGA
	02 - 06		Aire Acondicionado	534 0212 10	PTA
	02 - 06		Sin Aire Acondicionado	534 0220 10	PTA

##### Ecosport

2.0L	04 -	L4, 16v, DOHC		532 0320 10	PGA
				534 0128 30	PTA

##### Escape

3.0L	2005	V6, 24v, DOHC		534 0225 10	PTA
	01 - 04			534 0230 10	PTA
				534 0238 10	PTA

##### Excursion

6.8L	01 - 05	V10, 20v, OHC		532 0486 10	PGA
				534 0212 10	PTA

##### Expedition

4.6L	97 - 01	V8, 16v, OHC		532 0486 10	PGA
	02 - 04	V8, 16v, OHC		534 0212 10	PTA
5.4L	97 - 01	V8, 16v, OHC	Triton	531 0437 30	PTA
				532 0486 10	PGA
	02 - 06	V8, 16v, OHC	Triton	534 0212 10	PTA

##### Explorer

4.0L	91 - 01	V6, 12v, OHC		531 0441 20	PTA
	91 - 94	V6, 12v, OHV		534 0194 10	PTA
	00 - 06	V6, 12v, OHV		534 0198 10	PTA
	91 - 94	V6, 12v, OHV		532 0484 10	PGD
4.6L	02 - 06	V8, 16v, OHC		534 0212 10	PTA
5.0L	95 - 96	V8, 16v, OHV		531 0794 10	PGD
	95 - 01	V8, 16v, OHV		534 0201 10	PTA
		V8, 16v, OHV		532 0484 10	PGD

##### F 150

3.8L	80 - 93	V6, 12v, OHV		532 0274 20	PGA
4.2L	98 - 05	V6, 12v, OHV		531 0794 10	PGD
4.9L	95 - 97	L6, 12v, OHC		531 0433 20	PTA
				532 0486 10	PGA
				534 0193 10	PTA



## APLICACIONES POR MARCAS

					<b>SIGLAS</b>
--	--	--	--	--	---------------

### FORD

#### CAMIONETA (PICK-UP/SUV/VAN/MINIVAN)

##### F 200

5.0L	87 - 92	V8, 16v, OHV		531 0433 20	PTA
	85 - 86			532 0488 10	PGA



##### F 250

4.6L	97 - 01	V8, 16v, OHC		531 0797 10	PGD
				532 0486 10	PGA
				534 0218 10	PTA
4.9L	1995	L6, 12v, OHC		534 0212 10	PTA
				534 0220 10	PTA
5.0L	96 - 97	V8, 16v, OHC		531 0794 10	PGD
	92 - 97			532 0278 20	PGA
5.4L	99 - 01	V8, 16v, OHC		531 0797 10	PGD
	99 - 01			532 0486 10	PGA
	99 - 01			534 0218 10	PTA
	99 - 04		Triton	531 0463 20	PTA
	99 - 06		Triton	531 0462 20	PTA
	99 - 06			532 0275 20	PGA
	02 - 06			534 0212 10	PTA
	02 - 06			534 0220 10	PTA
5.8L	92 - 97	V8, 16v, OHC		531 0794 10	PGD
	94 - 95		Triton	532 0278 20	PGA
	94 - 98		Triton	531 0462 20	PTA
	94 - 98		Triton	531 0463 20	PTA

##### F 350

4.9L	1995	V8, 16v, OHC		531 0433 20	PTA
				532 0486 10	PGA
5.0L	86 - 94	V8, 16v, OHC		531 0433 20	PTA
	93 - 95			532 0278 20	PGA
5.4L	99 - 01	V8, 16v, OHC		531 0797 10	PGD
				532 0486 10	PGA
				534 0218 10	PTA
	99 - 05			531 0462 20	PTA
			Triton	531 0463 20	PTA
				534 0212 10	PTA
02 - 05			534 0220 10	PTA	

## APLICACIONES POR MARCAS

					<b>SIGLAS</b>
---	---	---	---	---	---------------

### FORD

#### CAMIONETA (PICK-UP/SUV/VAN/MINIVAN)

##### F 350

5.8L	1988	V8, 16v, OHC		531 0794 10	PGD
	90 - 95			532 0278 20	PGA
	93 - 98			531 0462 20	PTA
				531 0463 20	PTA

##### F 450

6.8L	98 - 01	V10, 20v, OHV		534 0218 10	PTA
	98 - 04		Triton	531 0437 30	PTA
	99 - 05		Triton	532 0277 20	PGA
	02 - 04			534 0212 10	PTA
7.3L	00 - 03	V8, 16v, OHV		531 0438 30	PTA
				532 0277 20	PGA
7.5L	97 - 98	V8, 16v, OHV		531 0438 30	PTA
				532 0277 20	PGA

##### F 550

6.8L	03 - 05	V10, 20v, OHV	Triton	531 0437 30	PTA
			Triton	532 0277 20	PGA
				532 0486 10	PGA
			Aire Acondicionado	534 0212 10	PTA
				534 0220 10	PTA

##### Freestar

4.2L	00 - 06	V6, 12v, DOHC		534 0214 10	PTA
------	---------	---------------	--	-------------	-----

##### Mariner

3.0L	05 -	V6, 24v, DOHC		534 0225 10	PTA
------	------	---------------	--	-------------	-----

##### Ranger

2.3L	96 - 02	L4, 8v, OHC		531 0368 10	PTD
				532 0263 20	PGA
				534 0196 10	PTA
2.5L	98 - 01	L4, 8v, OHC		531 0368 10	PTD
				532 0263 20	PGA
				534 0196 10	PTA
3.0L	96 - 01	V6, 12v, OHV		531 0461 20	PTA

##### Windstar

3.8L	95 - 98	V6, 12v, OHV		532 0485 10	PGA
	98 - 03	V6, 12v, OHV		531 0459 20	PTA
	99 - 04	V6, 12v, OHV		534 0199 10	PTA



## APLICACIONES POR MARCAS

					<b>SIGLAS</b>
--	--	--	--	--	---------------

### CHEVROLET

Astra					
1.8L	00 - 06	L4, 16v, DOHC		531 0518 30	
	00 -			532 0602 20	
				532 0033 10	
2.0L	04 - 06	L4, 8v, OHC	TBT	531 0273 30	PTD
				532 0040 10	PGD
				532 0602 20	PGA
2.2L	01 - 03	L4, 16v, DOHC		531 0298 30	PTA
2.4L	04 - 06	L4, 16v, DOHC		531 0054 30	PTD
				532 0087 10	PGD

Blazer					
4.3L	95 - 01	V6, 12v, OHV	Aire Acondicionado	531 0448 20	PTA
				531 0451 20	PTA
				532 0263 20	PGA
				532 0265 20	PGA
				532 0269 20	PGA
	1995	V6, 12v, OHV		532 0276 20	PGA





Camaro					
Z28 5.7L	95 - 02	V8, 16v, OHV		532 0263 20	PGA
				532 0269 20	PGA
			Aire Acondicionado	534 0227 10	PTA
				534 0231 10	PTA

Cavalier					
2.2L	95 - 00	L4, 8v, OHV		531 0454 20	PTA
	95 - 02			532 0267 20	PGA
	95 - 04			534 0124 30	PGD
	01 - 04			531 0521 30	PTA
				534 0202 10	PTA
2.3L	1995	L4, 16v, DOHC		534 0124 30	PGD
2.4L	96 - 01	L4, 16v, DOHC		531 0795 10	PGA
	99 - 01	L4, 16v, DOHC		531 0454 20	PTA
				532 0267 20	PGA
2001	L4, 16v, DOHC		534 0213 10	PTA	
2.8L	90 - 94	V6, 12v, OHV		531 0794 10	PGD
Z24 3.1L	91 - 94	V6, 12v, OHV		531 0794 10	PGD

Celebrity					
2.8L	82 - 89	V6, 12v, OHV		531 0456 20	PTA
	87 - 89			531 0794 10	PGD



## APLICACIONES POR MARCAS

					<b>SIGLAS</b>
---	---	---	---	---	---------------

### CHEVROLET

#### Century

2.8L	83 - 94	V6, 12v, OHV		531 0456 20	PTA
	94 - 96	V6, 12v, OHV		531 0794 10	PGD

#### Chevy

1.4L	94 - 00	L4, 8v, OHC	Aire Acondicionado	532 0309 10	PGA
	94 - 01		Aire Acondicionado	531 0101 30	PTD
1.6L	94 - 00	L4, 8v, OHC	Aire Acondicionado, Dir. Hidráulica	532 0109 10	PGA
	96 - 03		Aire Acondicionado	531 0101 30	PTD
	96 - 03		Aire Acondicionado	532 0309 10	PGA
	96 - 03			532 0602 20	PGA
	00 - 05			531 0298 30	PTA

#### Citation

2.8L	82 - 86	V6, 12v, OHV		531 0456 20	PTA
------	---------	--------------	--	-------------	-----

#### Corsa

1.4L	02 - 03	L4, 16v, DOHC		532 0034 10	PGD
	02 - 03			532 0039 10	PGD
1.8L	03 -	L4, 8v, OHC		531 0518 30	PTD
	03 -		Aire Acondicionado, Dir. Hidráulica	531 1133 71	PGA
	03 -			532 0033 10	PGD
	03 -			532 0180 20	PGD

#### Corvette

5.7L	91 - 96	V8, 16v, OHV		531 0449 20	PTA
				532 0268 20	PGA
	91 - 04			532 0270 20	PGA
	95 - 04		Aire Acondicionado	534 0227 10	PTA
				534 0229 10	PTA

#### Cutlass

2.8L	87 - 88	V6, 12v, OHV		531 0456 20	PTA
Eurosport 2.8L	87 - 88	V6, 12v, OHV		531 0794 10	PGD
3.1L	89 - 96	V6, 12v, OHV		531 0456 20	PTA
Eurosport 3.1L	89 - 96	V6, 12v, OHV		531 0794 10	PGD

#### Impala

3.4L	00 -	V6, 12v, OHV		531 0456 20	PTA
				532 0263 20	PGA
3.8L	00 - 03	V6, 12v, OHV		531 0453 20	PTA
				531 0794 10	PGD
				532 0263 20	PGA
				532 0265 20	PGA
				534 0232 10	PTA



## APLICACIONES POR MARCAS

					<b>SIGLAS</b>
--	--	--	--	--	---------------

### CHEVROLET

Malibu					
2.2L	04 - 06	L4, 16v, DOHC		531 0521 30	PTA
				534 0124 30	PGD
2.4L	97 - 99	L4, 16v, DOHC		531 0795 10	PGA
				532 0263 20	PGA
				534 0124 30	PGD
				534 0213 10	PTA
3.1L	97 - 03	V6, 12v, OHV		531 0452 20	PTA
				532 0263 20	PGA
				532 0265 20	PGA

### Optra

2.0L	06 -	L4, 16v, DOHC		531 0298 30	PTA
------	------	---------------	--	-------------	-----

### Tigra

1.6L	1999	L4, 16v, DOHC		531 0518 30	PTD
------	------	---------------	--	-------------	-----

### CAMIONETA (PICK-UP/SUV/VAN/MINIVAN/CROSSOVER)

#### Avalanche

5.3L	02 -	V8, 16v, OHV		532 0270 20	PGA
			Aire Acondicionado	534 0226 10	PTA
				534 0236 10	PTA

#### Colorado

2.8L	04 - 06	L4, 16v, DOHC		531 0798 10	PGD
				534 0206 10	PTA
3.5L	04 - 06	L5, 20v, DOHC		531 0798 10	PGD
				534 0206 10	PTA



#### C 1500

4.3L	99 - 02	V6, 12v, OHC	Aire Acondicionado	531 0448 20	PTA
Silverado 4.3L	03 - 06	V6, 12v, OHC	Aire Acondicionado	531 0448 20	PTA
				531 0451 20	PTA
				532 0263 20	PGA
				532 0265 20	PGA
				532 0269 20	PGA
				532 0265 20	PGA
Silverado 4.8L	03 - 06	V8, 16v, OHV		532 0270 20	PGA
			Aire Acondicionado	534 0226 10	PTA
				534 0236 10	PTA

#### C 20

5.7L	90 - 94	V8, 16v, OHC		532 0276 20	PGA
------	---------	--------------	--	-------------	-----

## APLICACIONES POR MARCAS

					<b>SIGLAS</b>
---	---	---	---	---	---------------

### CHEVROLET

#### CAMIONETA (PICK-UP/SUV/VAN/MINIVAN/CROSSOVER)

##### C 2500

400 SS 5.7L	93 - 98	V8, 16v, OHC		532 0265 20	PGA
Cheyenne 5.7L	92 - 96	V8, 16v, OHC		532 0276 20	PGA
	93 - 02			531 0451 20	PTA
	95 - 02		Aire Acondicionado	532 0265 20	PGA
				531 0448 20	PTA
Silverado 5.3L	03 - 06	V8, 16v, OHV	Aire Acondicionado	532 0265 20	PGA
				532 0270 20	PGA
				534 0226 10	PTA
			Alternador / Bomba de agua / Dir. Hidráulica	534 0236 10	PTA

##### C 35

5.7L	90 - 94	V8, 16v, OHC		532 0276 20	PGA
------	---------	--------------	--	-------------	-----

##### C 3500

5.7L	90 - 95	V8, 16v, OHC		532 0276 20	PGA
	95 - 04	V8, 16v, OHC	Aire Acondicionado	531 0448 20	PTA
Silverado 5.7L	95 - 99	V8, 16v, OHV		531 0451 20	PTA
				532 0265 20	PGA
				532 0269 20	PGA
HD 7.4L	96 - 01	V8, 16v, OHV	Vortec	531 0451 20	PTA
				532 0265 20	PGA

##### Eighty Eight

3.8L	1995	V6, 12v, OHV		531 0794 10	PGD
------	------	--------------	--	-------------	-----

##### Express

5.3L	03 -	V8, 16v, OHV	Aire Acondicionado	534 0226 10	PTA
				534 0236 10	PTA
6.0L	03 -	V8, 16v, OHV	Aire Acondicionado	534 0226 10	PTA
				534 0236 10	PTA

##### Express 1500

Van 4.3L	00 - 03	V6, 12v, OHV		531 0450 20	PTA
				532 0265 20	PGA
				532 0269 20	PGA
Van 5.7L	97 - 02	V8, 16v, OHV		532 0265 20	PGA

##### Express 2500

Van 4.3L	00 - 03	V6, 12v, OHV		532 0265 20	PGA
Van 5.7L	97 - 02	V8, 16v, OHV	Sin Aire Acondicionado	531 0446 20	PTA
			Aire Acondicionado	531 0447 20	PTA
				532 0265 20	PGA



## APLICACIONES POR MARCAS

					<b>SIGLAS</b>
--	--	--	--	--	---------------

### CHEVROLET

#### CAMIONETA (PICK-UP/SUV/VAN/MINIVAN/CROSSOVER)

##### Express 3500

Van 4.3L	00 - 03	V6, 12v, OHV		532 0265 20	PGA
Van 5.7L	97 - 02	V8, 16v, OHV		531 0450 20	PTA
				532 0265 20	PGA

##### G 20

4.3L	94 - 95	V6, 16v, OHV	Sin Aire Acondicionado	531 0446 10	PTA
------	---------	--------------	------------------------	-------------	-----

##### Tracker

Geo 2.0L	97 - 00	L4, 16v, DOHC		532 0265 20	PGA
2.0L	99 - 04	L4, 16v, DOHC		531 0796 10	PGD
				534 0204 10	PTA

##### HHR

2.4L	06 -	L4, 16v, DOHC		531 0521 30	PTA
		L4, 16v, DOHC		534 0124 30	PGD

##### Lumina

APV 3.1L	95 - 96	V6, 12v, OHV		531 0794 10	PGD
3.8L	95 - 96	V6, 12v, OHV		531 0453 20	PTA
				532 0264 20	PGA

##### Luv

2.2L	99 - 05	L4, 8v, OHC		534 0203 10	PTA
------	---------	-------------	--	-------------	-----

##### Meriva

1.8L	04 - 05	L4, 16v, OHC		532 0033 10	PGD
------	---------	--------------	--	-------------	-----

##### P 30

5.7L	92 - 96	V8, 16v, OHC		531 0446 10	PTA
	97 - 02	V8, 16v, OHV		531 0448 20	PTA



##### P 31

5.7L	85 - 88	V8, 16v, OHV		532 0280 20	PGA
------	---------	--------------	--	-------------	-----

##### S 10

2.2L	94 - 98	L4, 8v, OHV		531 0800 10	PTA
	98 - 03			534 0203 10	PTA
4.3L	98 - 99	V6, 12v, OHV	Aire Acondicionado	531 0448 20	PTA
				531 0451 20	PTA
				532 0263 20	PGA
				532 0265 20	PGA
		532 0269 20	PGA		
		V6, 16v, OHV		534 0203 10	PTA
	91 - 95	V6, 16v, OHV		532 0276 20	PGA
	94 - 95	V6, 12v, OHV		532 0276 20	PGA

## APLICACIONES POR MARCAS

					<b>SIGLAS</b>
---	---	---	---	---	---------------

### CHEVROLET

#### CAMIONETA (PICK-UP/SUV/VAN/MINIVAN/CROSSOVER)

##### Sierra

5.3L	07 -	V8, 16v, OHV		531 0430 10	PGA
			Aire Acondicionado	534 0226 10	PTA
			Alternador / Bomba de agua / Dir. Hidráulica	534 0236 10	PTA

##### Silhouette

3.8L	94 - 95	V6, 12v, OHV		532 0485 10	PGA
------	---------	--------------	--	-------------	-----

##### Sonora

5.3L	03 - 06	V8, 16v, OHV		534 0226 10	PTA
			Alternador / Bomba de agua / Dir. Hidráulica	534 0236 10	PTA

##### Suburban

5.3L	03 -	V8, 16v, OHV	Aire Acondicionado	534 0226 10	PTA
				534 0236 10	PTA
5.7L	95 - 02	V8, 16v, OHV	Aire Acondicionado	531 0448 20	PTA
	96 - 99			531 0451 20	PTA
	87 - 01			532 0265 20	PGA
	90 - 95			532 0276 20	PGA

##### Tahoe

5.3L	07 -	V8, 16v, OHV	Aire Acondicionado	534 0226 10	PTA
				534 0236 10	PTA

##### Trail Blazer

4.2L	02 -	L6, 24v, DOHC		531 0798 10	PGD
				534 0206 10	PTA
5.3L	02 -	V8, 32v, DOHC		531 0430 10	PGA
				534 0226 10	PTA
			Alternador / Bomba de agua / Dir. Hidráulica	534 0236 10	PTA

##### Uplander

3.5L	05 - 06	V6, 12v, OHV		532 0265 20	PGA
------	---------	--------------	--	-------------	-----

##### Vectra

2.2L	03 - 05	L4, 16v, DOHC		531 0298 30	PTA
				531 0521 30	PTA
				534 0124 30	PGD
3.2L	03 - 05	V6, 24v, DOHC		531 0560 00	PTA

##### Venture

3.4L	97 - 04	V6, 12v, OHV		531 0452 20	PTA
				531 0456 20	PTA
				531 0794 10	PGD
				532 0265 20	PGA



## APLICACIONES POR MARCAS

					<b>SIGLAS</b>
--	--	--	--	--	---------------

### CHEVROLET

#### CAMIONETA (PICK-UP/SUV/VAN/MINIVAN/CROSSOVER)

Yukon					
5.3L	07 -	V8, 16v, OHV		532 0270 20	PGA
				534 0226 10	PTA
			Alternador / Bomba de agua / Dir. Hidráulica	534 0236 10	PTA
Zafira					
1.8L	02 - 05	L4, 16v, DOHC		531 0518 30	PTD
				532 0033 10	PGD
				532 0602 20	PGA
2.2L	02 - 06	L4, 16v, DOHC		531 0298 30	PTA
				531 0521 30	PTA
				534 0124 30	PGD





### HONDA

Accord					
2.2L	96 - 97	L4, 16v, OHC	VTEC (CE9) / F2272	531 0131 20	PTD
			VTEC (CE9) / F2272	531 0132 20	PTD
2.3L	98 - 02	L4, 16v, OHC	VTEC (CE9) / F2272	531 0131 20	PTD
			VTEC (CE9) / F2272	532 0132 20	PTD
	98 - 99	L4, 16v, OHC	VTEC (CE9) / F2272	532 0265 20	PGA
			VTEC (CE9) / F2272	532 0279 20	PGA
2.4L	03 - 06	L4, 16v, DOHC		534 0215 10	PTA
3.0L	98 - 02	V6, 24v, OHV	K9	531 0647 20	PTD
				532 0492 10	PGA
	03 - 06	V6, 24v, OHV		534 0219 10	PTA
			Aire Acondicionado	534 0233 10	PTA
Civic					
1.6L	97 - 00	L4, 16v, OHC		531 0314 20	PTD
				532 0279 20	PGA

#### CAMIONETA (SUV/MINIVAN)

CR V					
2.4L	02 - 06	L4, 16v, DOHC		534 0215 10	PTA
Odyssey					
3.5L	2000	V6, 24v, OHC	Aire Acondicionado	534 0233 10	PTA
			Aire Acondicionado	534 0234 10	PTA
	01 - 04	V6, 24v, OHC	Con Amortiguador Hidráulico, Aire Acondicionado	534 0235 10	PTA
				532 0492 10	PGA
	05 - 06	V6, 24v, OHC		534 0219 10	PTA

## APLICACIONES POR MARCAS

					<b>SIGLAS</b>
---	---	---	---	---	---------------

### HONDA

#### CAMIONETA (SUV/MINIVAN)

##### Pilot

3.5L	05 - 06	V6, 24v, OHC		532 0492 10	PGA
				534 0219 10	PTA
	03 - 04	V6, 24v, OHC	Aire Acondicionado	534 0234 10	PTA

### HUMMER

#### H2

6.0L	05 -	V8, 16v, OHV	Aire Acondicionado	534 0226 10	PTA
				534 0236 10	PTA

#### H3

3.5L	2006	L5, 20v, DOHC		531 0798 10	PGD
				534 0206 10	PTA

### INFINITI

#### I 30

3.0L	98 - 00	V6, 24v, DOHC		531 0214 20	PTD
				532 0280 20	PGA

### JAGUAR

#### S Type

4.0L	99 - 02	V8, 32v, DOHC		534 0225 10	PTA
------	---------	---------------	--	-------------	-----

#### XK Type

4.0L	98 - 02	V8, 32v, DOHC		534 0225 10	PTA
------	---------	---------------	--	-------------	-----

#### X Type

2.5L	01 - 05	V6, 24v, DOHC		534 0225 10	PTA
3.0L	01 - 05	V6, 24v, DOHC		534 0225 10	PTA

### JEEP

#### Cherokee

4.0L	96 - 01	L6, 12v, OHV		531 0430 20	PTA
			M242	532 0273 20	PGA
	98 - 01	L6, 12v, OHV	Con buje de 10mm.	532 0487 10	PGA
			Con buje de 10mm.	532 0493 10	PGA

#### Grand Cherokee

3.7L	05 - 06	V6, 12v, OHC		532 0272 20	PGA
4.0L	95 - 02	L6, 12v, OHV		531 0457 20	PTA
	93 - 99		Con buje de 10mm.	532 0487 10	PGA
	98 - 04		Con buje de 10mm, Mecanismo Fijo	532 0493 10	PGA
				532 0494 10	PGA



## APLICACIONES POR MARCAS

					<b>SIGLAS</b>
--	--	--	--	--	---------------

### JEEP

#### Grand Cherokee

4.7L	99 - 05	V8, 16v, OHC	Con buje de 10mm.	532 0487 10	PGA
				534 0197 10	PTA
5.2L	93 - 98	V8, 16v, OHV		531 0430 10	PGA
				531 0793 10	PGA
5.2L	95 - 98	V8, 16v, OHV		531 0430 20	PTA
				531 0457 20	PTA
				532 0272 20	PGA
5.9L	1998	V8, 16v, OHV		531 0430 10	PGA
				532 0272 20	PGA

#### Liberty

3.7L	02 -	V6, 12v, OHC		532 0266 20	PGA
			Con buje de 10mm.	532 0487 10	PGA
				534 0197 10	PTA

#### Wagoneer

2.5L	91 - 94	L4, 8v, OHV	M150	532 0273 20	PGA
------	---------	-------------	------	-------------	-----

#### Wrangler

2.4L	03 - 06	L4, 8v, OHV	Con base de aluminio	531 0566 40	PTD
				532 0494 10	PGA
				534 0209 10	PTA
2.5L	87 - 02	L4, 8v, OHV	Con buje de 10mm.	532 0487 10	PGA
			Con buje de 10mm.	532 0493 10	PGA
			M150	532 0273 20	PGA
4.0L	91 - 94	L6, 12v, OHV		532 0273 20	PGA
	91 - 99	L6, 12v, OHV	Con buje de 10mm.	532 0487 10	PGA
	95 - 96	L6, 12v, OHV		531 0457 20	PTA
				532 0265 20	PGA
	00 - 06	L6, 12v, OHV	Con buje de 10mm.	532 0493 10	PGA
	L6, 12v, OHV		532 0494 10	PGA	

### LINCOLN

#### Continental

4.6L	97 - 99	V8, 32v, DOHC		531 0433 20	PTA
		V8, 32v, DOHC		531 0433 20	PTA

#### LS





3.0L	04 - 05	V6, 24v, DOHC		534 0225 10	PTA
3.9L	00 - 06	V8, 32v, DOHC		534 0225 10	PTA

#### Mark VIII

4.6L	95 - 96	V8, 32v, DOHC		531 0460 20	PTA
------	---------	---------------	--	-------------	-----



## APLICACIONES POR MARCAS

					<b>SIGLAS</b>
---	---	---	---	---	---------------

### LINCOLN

#### Town Car

4.6L	92 - 99	V8, 16v, OHC		531 0460 20	PTA
	95 - 06	V8, 16v, OHC		532 0263 20	PGA
	00 - 05	V8, 16v, OHC		531 0799 10	PGA
		V8, 16v, OHC		534 0211 10	PTA

### CAMIONETA (SUV)

#### Aviator

4.6L	03 - 05	V8, 32v, DOHC		534 0212 10	PTA
------	---------	---------------	--	-------------	-----

#### Navigator

5.4L	98 - 00	V8, 16v, OHC		532 0486 10	PGA
	01 - 05	V8, 32v, DOHC		534 0212 10	PTA

### MERCEDES BENZ

#### Clase A

160 1.6L	00 - 05	L4, 8v, OHC		532 0600 20	PGA
				532 0601 20	PGA
			Alternador	535 0045 10	PGL
190 1.9L	01 - 05	L4, 8v, OHC		532 0600 20	PGA
				532 0601 20	PGA
				532 0601 20	PGA

#### Clase C

220 2.2L	95 - 97	L4, 16v, DOHC		531 0563 00	PTA
				533 0017 10	THA
230 2.3L	97 - 98	L4, 16v, DOHC		531 0563 00	PTA
	96 - 03			533 0018 10	THA
260 2.6L	00 - 02	V6, 18v, OHC		531 0487 30	PTA
280 2.8L	95 - 98	L6, 24v, DOHC		532 0160 10	PGA
320 3.2L	01 - 02	V6, 18v, OHC		531 0487 30	PTA
36 3.6L	96 - 97	L6, 24v, DOHC		532 0489 10	PGA
				534 0006 10	PTA
43 4.3L	99 - 00	V8, 32v, OHC		531 0487 30	PTA

#### Clase CL

500 5.0L	02 - 04	V8, 24v, OHC		531 0487 30	PTA
	97 - 99	V8, 32v, DOHC		532 0160 10	PGA
600 5.5L	03 - 05	V12, 36v, DOHC		532 0234 10	PGA
600 5.8L	01 - 03	V12, 36v, DOHC		532 0234 10	PGA
600 6.0L	97 - 99	V8, 32v, DOHC		532 0233 10	PGA
AMG 65 6.0L	2005	V12, 36v, OHC		532 0234 10	PGA



## APLICACIONES POR MARCAS

					<b>SIGLAS</b>
--	--	--	--	--	---------------

### MERCEDES BENZ

#### Clase CLK

320 3.2L	97 - 05	V6, 18v, OHC		531 0487 30	PTA
	98 - 05	V6, 18v, OHC	Cabrio	533 0018 10	THA
430 4.3L	99 - 02	V8, 24v, OHC		531 0487 30	PTA

#### Clase E

320 3.2L	96 - 97	L6, 24v, DOHC		531 0018 10	PTA
				531 0488 30	PTA
		L6, 24v, DOHC		533 0018 10	THA
		L6, 18v, DOHC		532 0489 10	PGA
				534 0006 10	PTA
	98 - 01	V6, 18v, OHC		531 0487 30	PTA
430 4.3L	98 - 02	V8, 24v, OHC		531 0487 30	PTA
55 5.5L	99 - 01	V8, 24v, OHC		531 0487 30	PTA

#### Clase S

430 4.3L	99 - 04	V8, 24v, OHC		531 0487 30	PTA
500 5.0L	96 - 98	V8, 32v, DOHC		532 0030 10	PGA
				532 0031 10	PGA
	00 - 02	V8, 24v, OHC		531 0487 30	PTA
600 5.5L	03 - 05	V12, 36v, OHC		532 0234 10	PGA
600 5.8L	02 - 03	V12, 36v, OHC		532 0234 10	PGA
600 6.0L	96 - 98	V12, 48v, DOHC		532 0028 10	PGA
	2005	V12, 36v, OHC		532 0234 10	PGA

#### Clase SL

320 3.2L	96 - 97	L6, 24v, DOHC		531 0488 30	PTA
				534 0006 10	PTA
500 5.0L	96 - 98	V8, 32v, DOHC		532 0030 10	PGA
				532 0031 10	PGA
	99 - 01	V8, 24v, OHC		531 0487 30	PTA
600 6.0L	96 - 98	V12, 48v, DOHC		532 0028 10	PGA

#### Clase SLK

230 2.3L	97 - 00	L4, 16v, DOHC		531 0563 00	PTA
	97 - 04	L4, 16v, DOHC		533 0018 10	THA
320 3.2L	01 - 04	V6, 18v, OHC		531 0487 30	PTA

### CAMIONETA (VAN,SUV)



#### Clase G

500 5.0L	02 - 05	V8, 24v, OHC		531 0487 30	PTA
----------	---------	--------------	--	-------------	-----

#### Clase ML

320 3.2L	98 - 03	V6, 18v, OHV		531 0487 30	PTA
430 4.3L	98 - 01	V8, 24v, OHC		531 0487 30	PTA

## APLICACIONES POR MARCAS

					<b>SIGLAS</b>
---	---	---	---	---	---------------

### MERCEDES BENZ

#### CAMIONETA (VAN,SUV)

##### Clase ML

500 5.0L	02 - 06	V8, 24v, OHC		531 0487 30	PTA
55 5.5L	2001	V8, 24v, OHC		531 0487 30	PTA

##### Sprinter

2.7L Diesel	04 - 06	L5, 20v, OHC		533 0017 10	THA
2.1L Turbo Diesel	07 -	L4, 16v, OHC		532 0160 10	PGA
2.1L Turbo Diesel	07 -	L4, 16v, OHC		532 0304 10	PGA

### MITSUBISHI

##### Galant

2.4L	2004	L4, 16v, OHC	GDi EA3A / 4G64	531 0121 20	PGD
			GDi EA3A / 4G64	531 0193 20	PTD
	04 - 06	L4, 16v, OHC		532 0074 20	PGD

##### Lancer

2.0L	04 - 06	L4, 16v, OHC		532 0074 20	PGD
------	---------	--------------	--	-------------	-----

### NISSAN

##### 300ZX

3.0L	91 - 96	V6, 24v, DOHC		531 0214 20	PTD
------	---------	---------------	--	-------------	-----

##### Altima

2.4L	96 - 01	L4, 16v, DOHC		532 0264 20	PGA
				532 0280 20	PGA
2.5L	02 - 06	L4, 16v, DOHC		534 0216 10	PTA

##### Hikari

1.6L	88 - 92	L4, 8v, OHC		531 0208 20	PTD
------	---------	-------------	--	-------------	-----

##### Maxima

3.0L	95 - 99	V6, 24v, DOHC		531 0214 20	PTD
				532 0280 20	PGA

##### Platina

1.6L	02 -	L4, 16v, DOHC		531 0409 30	PTD
				531 0427 10	PTA
				532 0221 10	PGD
				532 0243 10	PGA

##### Samurai

1.6L	85 - 87	L4, 8v, OHC		531 0208 20	PTD
------	---------	-------------	--	-------------	-----

##### Sentra

2.5L	02 - 06	L4, 16v, DOHC		534 0216 10	PTA
------	---------	---------------	--	-------------	-----



## APLICACIONES POR MARCAS

					<b>SIGLAS</b>
--	--	--	--	--	---------------



### NISSAN

Tsubame					
1.6L	87 - 91	L4, 8v, OHC		531 0208 20	PTD
Tsuru I					
1.5L	84 - 85	L4, 8v, OHC		531 0208 20	PTD
1.6L	86 - 87	L4, 8v, OHC		531 0208 20	PTD
Tsuru II					
1.6L	88 - 91	L4, 8v, OHC		531 0208 20	PTD
Tsuru III					
1.6L	95 - 97	L4, 8v, OHC		531 0208 20	PTD

### CAMIONETA (PICK-UP/SUV/VAN/MINIVAN/CROSSOVER)

Armada					
5.6L	04 -	V8, 32v, DOHC		534 0224 10	PTA
Estaquitas					
2.4L	91 - 95	L4, 12v, OHC		532 0497 10	PGA
Frontier					
2.4L	01 - 04	L4, 16v, DOHC		532 0280 20	PGA
3.3L	01 - 04	V6, 12v, OHC		531 0214 20	PTD
		V6, 12v, OHC		532 0280 20	PGA
		V6, 12v, OHC		532 0485 10	PGA
Ichivan					
2.4L	1993	L4, 8v, OHC		532 0497 10	PGA
Pick up					
2.4L	94 - 05	L4, 12v, OHC		532 0280 20	PGA
	90 - 97			532 0497 10	PGA
Quest					
3.0L	97 - 98	V6, 12v, OHC		531 0214 20	PTD
				532 0280 20	PGA
3.3L	99 - 02	V6, 12v, OHC		532 0280 20	PGA
Titan					
5.6L	04 -	V8, 32v, DOHC		534 0224 10	PTA
Urvan					
2.4L	00 - 03	L4, 16v, OHV		532 0280 20	PGA
	03 -	L4, 16v, DOHC		532 0280 20	PGA
X Terra					
2.4L	00 - 04	L4, 16v, DOHC		531 0214 20	PTD
				532 0280 20	PGA

## APLICACIONES POR MARCAS

					<b>SIGLAS</b>
---	---	---	---	---	---------------

### NISSAN

#### CAMIONETA (PICK-UP/SUV/VAN/MINIVAN/CROSSOVER)

##### X Terra

3.3L	00 - 04	V6, 12v, OHC		531 0214 20	PTD
				532 0280 20	PGA
				532 0485 10	PGA

##### X Trail

2.5L	02 -	L4, 16v, DOHC		534 0216 10	PTA
------	------	---------------	--	-------------	-----

### PEUGEOT

#### 206

1.4L	00 -	L4, 8v, OHC		531 0030 10	PTD
				531 0306 10	PTA
1.6L	01 -	L4, 16v, DOHC		531 0478 10	PTD
				532 0142 10	PGD
			Todos	532 0142 10	PGD
				534 0037 10	THB

#### 306

1.6L	97 - 98	L4, 8v, OHC		531 0241 10	PTD
1.8L	98 - 00	L4, 8v, OHC		532 0139 10	PGA
				531 0265 10	PTA
	98 - 02	L4, 16v, OHC		531 0353 10	PTA
				532 0139 10	PGA
				533 0072 20	PTA
	2.0L	01 - 02	L4, 16v, OHC		531 0047 10
				532 0123 10	PGA
				533 0072 20	PTA

#### 307

2.0L	03 -	L4, 16v, DOHC		531 0479 10	PGD
			Motor RFN (EW10J4) 100 kw	531 0546 10	PTD
				534 0022 10	PTA

#### 405

2.0L	97 - 99	L4, 16v, DOHC		531 0096 10	PTA
				532 0138 10	PGA



## APLICACIONES POR MARCAS

					<b>SIGLAS</b>
--	--	--	--	--	---------------

### PEUGEOT

406

2.0L	02 - 05	L4, 16v, DOHC		531 0047 10	PTD
				531 0258 10	PTA
				531 0479 10	PGD
				532 0020 10	PGD
				532 0123 10	PGA
				532 0124 10	PGA
				534 0022 10	PTA
3.0L	00 - 02	V6, 24v, DOHC		531 0258 10	PTA

### PONTIAC

Bonneville

3.8L	95 - 99	V6, 12v, OHV		531 0453 20	PTA
				531 0794 10	PGD
				532 0271 20	PGA
				532 0279 20	PGA

Firebird

5.7L	94 - 99	V8, 16v, OHV	Aire Acondicionado	534 0227 10	PTA
				534 0231 10	PTA
	94 - 01	V8, 16v, OHV		531 0449 20	PTA
				532 0270 20	PGA

Grand am

3.4L	94 - 01	V6, 12v, OHV		531 0452 20	PTA
				532 0263 20	PGA





Grand Prix

3.1L	97 - 98	V6, 12v, OHV		531 0794 10	PGD
3.8L	97 - 97	V6, 24v, DOHC		531 0794 10	PGD
	97 - 01	V6, 12v, OHV		531 0794 10	PGD
		V6, 12v, DOHC		532 0263 20	PGA

Sunfire

2.2L	02 - 05	L4, 16v, DOHC		534 0124 30	PGD
				534 0202 10	PTA
2.4L	97 - 01	L4, 16v, DOHC		531 0452 20	PTA
				531 0455 20	PTA
				531 0795 10	PGA
				534 0124 30	PGD
				534 0213 10	PTA

## APLICACIONES POR MARCAS

					<b>SIGLAS</b>
---	---	---	---	---	---------------

### CAMIONETA (SUV)

#### Aztek

3.4L	01 - 05	V6, 12v, OHV		531 0452 20	PTA
				532 0265 20	PGA

### PORSCHE

#### 911

3.4L	99 - 02	L6, 24v, DOHC	Alternador	535 0025 10	PGL
------	---------	---------------	------------	-------------	-----

#### Boxster

2.7L	01 - 04	L6, 24v, DOHC	Alternador	535 0025 10	PGL
3.2L	01 - 04	L6, 24v, DOHC	Alternador	535 0025 10	PGL
	01 - 04	L6, 24v, DOHC	Alternador	535 0025 10	PGL

### RENAULT

#### Clio

1.6L	02 -	L4, 16v, DOHC		531 0409 30	PTD
				531 0427 10	PTA
				532 0243 10	PGA
				532 0221 10	PGD
Sport 2.0L	02 - 06	L4, 16v, DOHC		531 0410 30	PTD
				532 0143 10	PGA
				532 0308 10	PGD
				532 0446 10	PGD

#### Laguna

2.0L	2006	L4, 16v, DOHC		532 0221 10	PGD
------	------	---------------	--	-------------	-----

#### Megane

2.0L	01 -	L4, 16v, DOHC		531 0410 30	PTD
				532 0143 10	PGA
				532 0221 10	PGD
				532 0308 10	PGD
				532 0446 10	PGD
				534 0036 10	THB

### CAMIONETA (MINIVAN)

#### Scenic

2.0L	01 -	L4, 16v, DOHC		532 0308 10	PGD
				532 0446 10	PGD

### SEAT

#### Cordoba

1.6L	01 -	L4, 8v, OHC		531 0252 30	PTD
				531 0288 30	PTA



## APLICACIONES POR MARCAS

					<b>SIGLAS</b>
--	--	--	--	--	---------------

### SEAT

#### Ibiza

1.6L	01 -	L4, 8v, OHC		531 0252 30	PTD
				531 0288 30	PTA
2.0L	03 -	L4, 8v, OHC		532 0603 20	PGA

#### Leon

1,8	01 - 05	L4, 20v, DOHC	Alternador BOSCH 70A/90A	535 0012 10	PGL
				531 0288 30	PTA
1.8 Turbo	01 - 05	L4, 20v, DOHC		531 0500 20	PTD
				532 0161 10	PGD
				532 0312 20	PGD
				533 0030 20	THA

#### Toledo

1.8	01 - 05	L4, 20v, DOHC	Alternador BOSCH 70A/90A	535 0012 10	PGL
				531 0288 30	PTA
1.8 Turbo	01 - 05	L4, 20v, DOHC		531 0500 20	PTD
				532 0161 10	PGD
				532 0312 20	PGD
				533 0030 20	THA

### CAMIONETA (MINIVAN)

#### Alhambra

1.8L Turbo	02 -	L4, 20v, DOHC		531 0500 20	PTD
				532 0161 10	PGD
				533 0030 20	THA
			Alternador BOSCH 70A/90A	535 0012 10	PGL

### TOYOTA

#### Corolla





1.8L	03 -	L4, 16v, DOHC		532 0494 10	PGA
				532 0603 20	PGA
			5A-FE, 4A-FE, 7A-FE / XE	531 0181 20	PTD
				534 0016 10	PTHA

#### Camry

2.4L	02 - 06	L4, 16v, DOHC		533 0023 10	PTHA
3.0L	02 - 04	V6, 24v, DOHC	1MZ-FE(140KW) / 3VZ-FE(138KW)	531 0177 20	PTD
				532 0092 20	PGD



## APLICACIONES POR MARCAS

					<b>SIGLAS</b>
---	---	---	---	---	---------------

### TOYOTA

#### Matrix

1.8L	03 - 05	L4, 16v, DOHC		532 0494 10	PGA
				532 0603 20	PGA
				534 0016 10	PTHA

#### MR2 Spyder

1.8L	05 -	L4, 16v, DOHC		532 0494 10	PGA
				532 0603 20	PGA
				534 0016 10	PTHA

### CAMIONETA (PICK-UP/SUV/CROSSOVER)

#### 4 Runner

4.7L	03 -	V8, 32v, DOHC		532 0491 10	PGA
				534 0195 10	PTA

#### Land Cruiser

4.7L	04 - 06	V8, 32v, DOHC		534 0195 10	PTA
	05 - 06	V8, 32v, DOHC		532 0491 10	PGA

#### RAV 4

2.4L	04 -	L4, 16v, DOHC		533 0023 10	PTHA
------	------	---------------	--	-------------	------

#### Tundra

4.7L	2007	V8, 32v, DOHC		532 0491 10	PGA
				534 0195 10	PTA

### VOLKSWAGEN

#### Atlantic

1.7L	77 - 87	L4, 8v, OHC	Pais de origen: Alemania	531 0063 10	PTD
			Pais de origen: Brasil	531 0063 11	PTD

#### Bora

1.9L Diesel	2007	L4, 8v, OHC		531 0436 20	PTD
	06 -			532 0111 10	PGD

#### Cabrio

2.0L	96 - 02	L4, 8v, OHC	Alternador	532 0067 10	PGA
------	---------	-------------	------------	-------------	-----

#### Caribe





1.7L	77 - 87	L4, 8v, OHC	Pais de origen: Alemania	531 0063 10	PTD
			Pais de origen: Brasil	531 0063 11	PTD

#### Corsar

1.8L	84 - 88	L4, 8v, OHC	Pais de origen: Alemania	531 0063 10	PTD
			Pais de origen: Brasil	531 0063 11	PTD

#### Derby

1.8L	00 -	L4, 8v, OHC		531 0252 30	PTD
------	------	-------------	--	-------------	-----

					<b>SIGLAS</b>
--	---	---	---	---	---------------

## VOLKSWAGEN

### Golf

A2 1.8L	89 - 92	L4, 8v, OHC	Pais de origen: Alemania	531 0063 10	PTD
			Pais de origen: Brasil	531 0063 11	PTD
A3 1.8L	92 - 99	L4, 8v, OHC	Pais de origen: Alemania	531 0063 10	PTD
			Pais de origen: Brasil	531 0063 11	PTD
				531 0083 10	PTD
				532 0067 10	PGA
A3 GTI 2.0L	92 - 99	L4, 8v, OHC		531 0083 10	PTD
A3 2.0L	93 - 99	L4, 8v, OHC		532 0067 10	PGA
A3 VR6 2.8L	96 - 99	V6, 12v, DOHC		534 0126 30	PTA
A4 1.8L	00 - 01	L4, 8v, OHC	Alternador BOSCH 70A/90A	535 0012 10	PGL
	00 - 03	L4, 20v, OHC		532 0494 10	PGA
	01 - 05	L4, 20v, DOHC	Alternador	531 0286 30	PTA
				531 0500 20	PTD
			Alternador	532 0067 10	PGA
			532 0312 20	PGD	
A4 1.8L Turbo	01 - 06	L4, 20v, DOHC		531 0333 20	PTD
				532 0603 20	PGA
				533 0030 20	THA
A4 2.0L	00 - 01	L4, 8v, OHC		532 0494 10	PGA
	00 - 03	L4, 8v, OHC	Alternador BOSCH 70A/90A	535 0012 10	PGL
	00 -	L4, 8v, OHC	1MZ-FE(140KW) / 3VZ-FE(138KW)	531 0203 20	PTD
			Alternador	531 0286 30	PTA
			Alternador	532 0067 10	PGA
				532 0161 10	PGD
			532 0603 20	PGA	
A4 2.0L Turbo	00 -	L4, 8v, OHC		531 0288 30	PTA

### Jetta

A2 1.8L	89 - 92	L4, 8v, OHC	Pais de origen: Alemania	531 0063 10	PTD
			Pais de origen: Brasil	531 0063 11	PTD
A3 1.8L	93 - 99	L4, 8v, OHC	Pais de origen: Alemania	531 0063 10	PTD
			Pais de origen: Brasil	531 0063 11	PTD
A3 1.8L	93 - 99	L4, 8v, OHC		531 0083 10	PTD
			Alternador	532 0067 10	PGA
A3 1.8L	97 - 99	L4, 8v, OHC	Alternador	531 0286 30	PTA
A3 2.0L	93 - 99	L4, 8v, OHC		531 0083 10	PTD
			Alternador	532 0067 10	PGA
A3 VR6 2.8L	93 - 98	V6, 12v, DOHC		534 0126 30	PTA

## APLICACIONES POR MARCAS

					<b>SIGLAS</b>
--	--	--	--	--	---------------

### VOLKSWAGEN

#### Jetta

A4 1.8L	98 - 99	L4, 8v, OHC	Alternador	531 0286 30	PTA
	00 - 05	L4, 20v, DOHC		531 0500 20	PTD
			Alternador	532 0067 10	PGA
				532 0312 20	PGD
				532 0494 10	PGA
		532 0603 20	PGA		
	00 - 06	L4, 20v, DOHC	Alternador BOSCH 70A/90A	535 0012 10	PGL
A4 1.8L Turbo	00 - 05	L4, 20v, DOHC		533 0030 20	THA
				531 0333 20	PTD
A4 2.0L	97 - 06	L4, 8v, OHC		531 0286 30	PTA
	99 - 05	L4, 8v, OHC	1MZ-FE(140KW) / 3VZ-FE(138KW)	531 0203 20	PTD
				531 0288 30	PTA
				532 0067 10	PGA
				532 0161 10	PGD
				532 0494 10	PGA
		532 0603 20	PGA		
	99 - 06	L4, 8v, OHC	Alternador	535 0012 10	PGL





#### Lupo

1.6L	00 - 05	L4, 16v, DOHC	Centroamérica	531 0317 10	PTD
				531 0339 10	PTD
	05 -	L4, 8v, OHC		532 0167 10	PGD
				532 0185 10	PGD

#### New Beetle

1.8L Turbo	00 - 05	L4, 20v, DOHC		532 0494 10	PGA
			Alternador BOSCH 70A/90A	535 0012 10	PGL
				531 0500 20	PTD
			Alternador	532 0067 10	PGA
				532 0312 20	PGD
			532 0603 20	PGA	
2.0L	98 -	L4, 8v, OHC	1MZ-FE(140KW) / 3VZ-FE(138KW)	531 0203 20	PTD
				531 0288 30	PTA
			Alternador	532 0067 10	PGA
				532 0161 10	PGD
				532 0494 10	PGA
				532 0603 20	PGA
				Alternador BOSCH 70A/90A	535 0001 10
	Alternador BOSCH 70A/90A	535 0012 10	PGL		

## APLICACIONES POR MARCAS

					<b>SIGLAS</b>
--	---	---	---	---	---------------





### VOLKSWAGEN

Passat					
1.8 Turbo	99 - 01	L4, 20v, DOHC		531 0537 30	PTA
	99 - 05	L4, 20v, DOHC	Aire Acondicionado	531 0309 10	PTA
		L4, 20v, DOHC		532 0603 20	PGA
	99 - 06	L4, 20v, DOHC		531 0333 20	PTD
2.0L	91 - 93	L4, 8v, OHC		532 0603 20	PGA
			Alternador BOSCH 70A/90A	535 0001 10	PGL
	06 - 07	L4, 16v, DOHC		532 0494 10	PGA
2.8L	96 - 97	V6, 12v, DOHC		533 0037 20	THB
				534 0126 30	PTA
	99 - 05	V6, 24v, DOHC		531 0490 30	PTA
				532 0603 20	PGA
02 - 05	V6, 30v, DOHC	AGA, AGJ,ACK motion	532 0159 10	PGD	

Pointer						
1.8L	98 - 00	L4, 8v, OHV	Aire Acondicionado	531 0439 20	PTA	
			Aire Acondicionado, Dir. Hidráulica	531 0440 20	PTA	
			Alternador	532 0067 10	PGA	
			Aire Acondicionado, Dir. Hidráulica	532 0263 20	PGA	
	00 - 01	L4, 8v, OHC		531 0063 10	PTD	
				531 0063 11	PTD	
	00 - 06	L4, 8v, OHC	Aire Acondicionado	531 0439 20	PTA	
			Aire Acondicionado, Dir. Hidráulica	531 0440 20	PTA	
			Alternador	532 0067 10	PGA	
			Aire Acondicionado, Dir. Hidráulica	532 0263 20	PGA	
	2.0L	00 - 03	L4, 8v, OHC	Aire Acondicionado	531 0439 20	PTA
				Aire Acondicionado, Dir. Hidráulica	531 0440 20	PTA
Alternador				532 0067 10	PGA	
Aire Acondicionado, Dir. Hidráulica				532 0263 20	PGA	

Polo					
1.6L	00 - 05	L4, 16v, DOHC	Centroamérica	531 0317 10	PTD
				531 0339 10	PTD
	03 -	L4, 8v, OHC		531 0252 30	PTD
			Alternador	532 0067 10	PGA
				532 0167 10	PGD
				532 0185 10	PGD
			Dir. Hidráulica	534 0123 20	PTA

## APLICACIONES POR MARCAS

					<b>SIGLAS</b>
---	---	---	---	---	---------------

### VOLKSWAGEN

#### CAMIONETA (VAN/MINIVAN)

##### Sharan

1.8L Turbo	02 -	L4, 20v, DOHC		531 0500 20	PTD
			Alternador	532 0067 10	PGA
				532 0312 20	PGD
				533 0030 20	THA
			Alternador BOSCH 70A/90A	535 0012 10	PGL

##### Eurovan

1.9L Diesel	06 -	L4, 8v, OHV		531 0079 10	PTD
				531 0251 30	PTD
				531 0440 30	PTD
				533 0086 30	PTA
2.5L	01 - 04	L5, 10v, DOHC		531 0276 30	PTD
				531 0278 30	PTD
				532 0051 10	PGD
			Alternador	532 0067 10	PGA
			Aire Acondicionado, Alternador	532 0150 10	PGA
				532 0162 10	PGA
			Dir. Hidráulica	532 0169 10	PGA
				532 0496 10	PGA
	533 0086 30	PTA			

##### Combi

1.8L	86 - 01	L4, 8v, OHC	Pais de origen: Alemania	531 0063 10	PTD
			Pais de origen: Brasil	531 0063 11	PTD

### VOLVO

#### C70

2.3L Turbo	99 - 01	L5, 20v, DOHC		531 0312 10	PTD
				532 0242 10	PGA
				532 0317 10	PGD

#### S40

2.0L Turbo	99 - 04	L4, 16v, DOHC		532 0242 10	PGA
				532 0317 10	PGD
				531 0312 10	PTD

#### S60

2.0L Turbo	01 - 04	L5, 20v, DOHC		531 0312 10	PTD
				532 0242 10	PGA
				532 0317 10	PGD



## APLICACIONES POR MARCAS

					<b>SIGLAS</b>
--	--	--	--	--	---------------

### VOLVO

#### S60

2.3L Turbo	01 - 03	L5, 20v, DOHC		531 0334 10	PTA
2.4L Turbo	01 - 03	L5, 20v, DOHC		531 0312 10	PTD
				532 0242 10	PGA
				532 0317 10	PGD

#### S70

2.4L Turbo	99 - 00	L5, 20v, DOHC		531 0090 10	PTD
				531 0312 10	PTD
2.4L Turbo	99 - 00	L5, 20v, DOHC		532 0242 10	PGA
				532 0317 10	PGD

#### S80

2.9L Turbo	00 - 05	L6, 24v, DOHC		531 0334 10	PTA
------------	---------	---------------	--	-------------	-----





#### V40

2.0L Turbo	99 - 04	L4, 16v, DOHC		532 0242 10	PGA
				532 0317 10	PGD
				531 0312 10	PTD

#### V70

2.3L Turbo	00 - 03	L5, 20v, DOHC		531 0090 10	PTD
				531 0312 10	PTD
				532 0242 10	PGA
				532 0317 10	PGD
2.4L Turbo	99 - 03	L5, 20v, DOHC		531 0334 10	PTA

## KITS Y SETS

				<b>SET</b>	<b>KIT</b>	<b>TENSORES Y POLEAS</b>			
---	---	---	---	------------	------------	--------------------------	--	--	--

<b>AUDI</b>										
<b>A3</b>										
1.8L Turbo	98 - 01	L4, 20v, DOHC			530 0067 09	530 0067 10	531 0500 20	533 0030 20		
<b>A4</b>										
1.8L Turbo	98 - 01	L4, 20v, DOHC			530 0180 09	530 0180 10	531 0531 20	532 0312 20		
<b>S3</b>										
1.8L Turbo	2000	L4, 20v, DOHC			530 0067 09	530 0067 10	5310 500 20	533 0030 20		
<b>TT</b>										
1.8L Turbo QUATTRO	99 - 00	L4, 20v, DOHC			530 0067 09	530 0067 10	531 0500 20	533 0030 20		
<b>CHRYSLER / DODGE</b>										
<b>300M</b>										
3.5L	98 - 04	V6, 24v, OHC				530 0028 10	531 0370 10			
<b>Cirrus</b>										
2.4L Turbo	97 - 01	L4, 16v, DOHC				530 0029 10	531 0371 10			
<b>Concorde</b>										
3.5L	95 - 97	V6, 24v, OHC				530 0025 10	531 0370 10			
<b>Dart K</b>										
2.2L	82 - 89	L4, 8v, OHC				530 0022 10	531 0326 10			
<b>Intrepid</b>										
3.5L	95 - 97	V6, 24v, OHC				530 0025 10	531 0370 10			
						530 0028 10	531 0370 10			
<b>Lebaron</b>										
K 2.2L	83 - 87	L4, 8v, OHC				530 0022 10	531 0326 10			
K 2.5L	92 - 95					530 0024 10	531 0364 10			
LHS 3.5L	96 - 97	V6, 24v, OHC				530 0025 10	531 0370 10			
<b>Magnum</b>										
2.2L	83 - 88	L4, 8v, OHC				530 0021 10	531 0364 10			
						530 0022 10	531 0326 10			
<b>Neon</b>										
2.0L	95 - 99	L4, 16v, DOHC				530 0026 10	531 0371 10			
						530 0027 10	531 0371 10			
	99 - 05					530 0402 10	531 0566 40			
<b>New Yorker</b>										
2.2L	91 - 94	L4, 8v, OHC				530 0022 10	531 0326 10			
	85 - 91					530 0023 10	531 0364 10			
2.5L	91 - 94	L4, 8v, OHC				530 0024 10	531 0364 10			
LHS 3.5L	1995	V6, 24v, OHC				530 0025 10	531 0370 10			

				<b>SET</b>	<b>KIT</b>	<b>TENSORES Y POLEAS</b>			
--	--	--	--	------------	------------	--------------------------	--	--	--

**CHRYSLER / DODGE**
**Phantom**

2.2L Turbo	87 - 89	L4, 8v, OHC			530 0022 10	531 0326 10			
2.5L	89 - 94	L4, 8v, OHC			530 0024 10	531 0364 10			

**PT cruiser**

2.4L	00 -	L4, 16v, DOHC			530 0029 10	531 0371 10			
------	------	---------------	--	--	-------------	-------------	--	--	--

**Shadow**

2.2L	89 - 90	L4, 8v, OHC			530 0021 10	531 0364 10			
2.5L	91 - 94	L4, 8v, OHC			530 0024 10	531 0364 10			

**Spirit**

2.5L	90 - 95	L4, 8v, OHC			530 0024 10	531 0364 10			
------	---------	-------------	--	--	-------------	-------------	--	--	--

**Stratus**

2.0L	96 - 97	L4, 16v, DOHC			530 0030 10	531 0370 10			
2.4L	95 - 02	L4, 16v, DOHC			530 0029 10	531 0371 10			

**Volare K**

2.2L	82 - 88	L4, 8v, OHC			530 0022 10	531 0326 10			
------	---------	-------------	--	--	-------------	-------------	--	--	--

**FIAT**
**Palio**

1.6L	04 - 06	L4, 16v, DOHC		530 0222 09	530 0222 10	531 0280 10	532 0209 10		
------	---------	---------------	--	-------------	-------------	-------------	-------------	--	--

**FORD**
**Contour**

2.0L	96 - 98	L4, 16v, DOHC		530 0102 09	530 0102 10	531 0021 10	532 0016 10	532 0093 10	
	98 - 00			530 0409 09	530 0409 10	531 0345 10	532 0151 10	532 0093 10	

**Escort**

1.8L	1995	L4, 16v, DOHC			530 0031 10	531 0021 10			
2.0L	97 - 01	L4, 16v, DOHC		530 0065 09	530 0065 10	531 0345 10	532 0151 10	532 0152 10	

**Fiesta**

1.3L	98 - 01	L4, 8v, OHV			530 0132 10	531 0019 10			
1.4L	98 - 00	L4, 16v, DOHC			530 0014 10	531 0020 10			
1.6L	01 - 04	L4, 8v, OHC			530 0014 10	531 0020 10			

**Focus**





2.0L	00 - 03	L4, 16v, DOHC		530 0065 09	530 0065 10	531 0345 10	532 0151 10	532 0152 10	
------	---------	---------------	--	-------------	-------------	-------------	-------------	-------------	--

**Mystique**

2.0L	1995	L4, 16v, DOHC		530 0102 09	530 0102 10	531 0021 10	532 0016 10	532 0093 10	
				530 0409 09	530 0409 10	531 0345 10	532 0151 10	532 0093 10	



## KITS Y SETS

				<b>SET</b>	<b>KIT</b>	<b>TENSORES Y POLEAS</b>			
---	---	---	---	------------	------------	--------------------------	--	--	--

### FORD

#### CAMIONETA (PICK-UP)

##### Ranger

2.3L	96 - 02	L4, 8v, OHC			530 0411 10	531 0368 10			
					530 0411 10	531 0368 10			

### CHEVROLET

##### Astra

1.8L	00 - 06	L4, 16v, OHC		530 0078 09	530 0078 10	531 0518 30	532 0033 10	532 0034 10	
2.0L	04 - 06	L4, 8v, OHC			530 0147 10	531 0273 30			
2.4L	04 - 06	L4, 16v, DOHC		530 0146 09	530 0146 10	531 0054 30	532 0087 10		

##### Chevy

1.4L	94 - 01	L4, 8v, OHC	Aire Acondicionado		530 0004 10	531 0101 30			
1.6L	96 - 03	L4, 8v, OHC	Aire Acondicionado		530 0004 10	531 0101 30			

##### Corsa

1.8L	03 - 05	L4, 8v, OHC		530 0077 09	530 0077 10	531 0518 30	532 0033 10	532 0180 20	
------	---------	-------------	--	-------------	-------------	-------------	-------------	-------------	--

#### CAMIONETA (MINIVAN)

##### Zafira

1.8L	02 - 05	L4, 16v, DOHC		530 0078 09	530 0078 10	531 0518 30	532 0033 10	532 0034 10	
------	---------	---------------	--	-------------	-------------	-------------	-------------	-------------	--

### HONDA

##### Accord

2.3L	98 - 02	L4, 16v, OHC	VTEC, OHC, EX, EXR	530 0414 09	530 0414 10	531 0131 20	532 0132 20		
------	---------	--------------	--------------------	-------------	-------------	-------------	-------------	--	--

##### Civic

1.6L	97 - 00	L4, 16v, OHC			530 0314 10	531 0314 20			
------	---------	--------------	--	--	-------------	-------------	--	--	--

### INFINITI

##### I 30

3.0L	98 - 00	V6, 24v, DOHC			530 0037 10	531 0214 20			
------	---------	---------------	--	--	-------------	-------------	--	--	--

### NISSAN

##### 300ZX

3.0L	91 - 96	V6, 24v, DOHC			530 0035 10	531 0214 20			
------	---------	---------------	--	--	-------------	-------------	--	--	--

##### Maxima

3.0L	95 - 99	V6, 24v, DOHC			530 0035 10	531 0214 20			
------	---------	---------------	--	--	-------------	-------------	--	--	--

##### Platina

1.6L	02 -	L4, 16v, DOHC		530 0092 09	530 0092 10	531 0409 30	532 0221 10		
------	------	---------------	--	-------------	-------------	-------------	-------------	--	--

				<b>SET</b>	<b>KIT</b>	<b>TENSORES Y POLEAS</b>			
--	--	--	--	------------	------------	--------------------------	--	--	--

**NISSAN**
**Samurai**

1.6L	85 - 87	L4, 8v, OHC			530 0263 10	531 0208 20			
------	---------	-------------	--	--	-------------	-------------	--	--	--

**Tsubame**

1.6L	87 - 91	L4, 8v, OHC			530 0263 10	531 0208 20			
------	---------	-------------	--	--	-------------	-------------	--	--	--

**Tsuru I**

1.6L	86 - 87	L4, 8v, OHC			530 0263 10	531 0208 20			
------	---------	-------------	--	--	-------------	-------------	--	--	--

**Tsuru II**

1.6L	88 - 91	L4, 8v, OHC			530 0263 10	531 0208 20			
------	---------	-------------	--	--	-------------	-------------	--	--	--

**Tsuru III**

1.6L	95 - 97	L4, 8v, OHC	GS, GST, GSX		530 0263 10	531 0208 20			
------	---------	-------------	--------------	--	-------------	-------------	--	--	--

**CAMIONETA (PICK-UP/SUV)**
**Frontier**

3.3L	01 - 04	V6, 12v, OHC	VG3		530 0036 10	531 0214 20			
------	---------	--------------	-----	--	-------------	-------------	--	--	--

**X-Terra**

3.3L	00 - 04	V6, 12v, DOHC	VG3		530 0036 10	531 0214 20			
------	---------	---------------	-----	--	-------------	-------------	--	--	--

**PEUGEOT**
**206**

1.4L	00 -	L4, 8v, OHC			530 0016 09	530 0016 10	531 0030 10		
------	------	-------------	--	--	-------------	-------------	-------------	--	--

1.6L	01 -	L4, 16v, DOHC			530 0237 09	530 0237 10	531 0478 10	532 0142 10	
------	------	---------------	--	--	-------------	-------------	-------------	-------------	--

**306**

2.0L	01 - 02	L4, 16v, OHC			530 0095 09	530 0095 10	531 0047 10	532 0020 10	
------	---------	--------------	--	--	-------------	-------------	-------------	-------------	--

**306**

2.0L	00 - 05	L4, 16v, DOHC			530 0095 09	5300095 10	531 0047 10	532 0020 10	
------	---------	---------------	--	--	-------------	------------	-------------	-------------	--

**RENAULT**
**Clio**

1.6L	02 -	L4, 16v, DOHC			530 0092 09	530 0092 10	531 0409 30	532 0221 10	
------	------	---------------	--	--	-------------	-------------	-------------	-------------	--

Sport 2.0L	02 - 06	L4, 16v, DOHC			530 0363 09	530 0363 10	531 0410 30	532 0308 10	532 0446 10
------------	---------	---------------	--	--	-------------	-------------	-------------	-------------	-------------





**Megane**

2.0L	01 -	L4, 16v, DOHC			530 0363 09	530 0363 10	531 0410 30	532 0308 10	532 0446 10
------	------	---------------	--	--	-------------	-------------	-------------	-------------	-------------

**CAMIONETA (MINIVAN)**
**Scenic**

2.0L	01 -	L4, 16v, DOHC			530 0363 09	530 0363 10	531 0410 30	532 0308 10	532 0446 10
------	------	---------------	--	--	-------------	-------------	-------------	-------------	-------------

## KITS Y SETS

				<b>SET</b>	<b>KIT</b>	<b>TENSORES Y POLEAS</b>			
---	---	---	---	------------	------------	--------------------------	--	--	--

<b>SEAT</b>									
<b>Cordoba</b>									
1.6L	01 -	L4, 8v, OHC			530 0167 10	531 0252 30			
<b>Ibiza</b>									
1.6L	01 - 02	L4, 8v, OHC			530 0167 10	531 0252 30			
<b>Leon</b>									
1.8L	01 - 05	L4, 20v, DOHC		530 0170 09	530 0170 10	531 0500 20	532 0312 20		
<b>Toledo</b>									
1.8L	01 - 05	L4, 20v, DOHC		530 0170 09	530 0170 10	531 0500 20	532 0312 20		
1.8L Turbo	01 - 05	L4, 20v, DOHC		530 0170 09	530 0170 10	531 0500 20	532 0312 20		
<b>CAMIONETA (MINIVAN)</b>									
<b>Alhambra</b>									
1.8L Turbo	02 -	L4, 16v, DOHC		530 0170 09	530 0170 10	531 0500 20	532 0312 20		
<b>VOLKSWAGEN</b>									
<b>Atlantic</b>									
1.7L	77 - 87	L4, 8v, OHC			530 0401 10	531 0063 11			
<b>Cabrio</b>									
1.8L	96 - 02	L4, 8v, OHC			530 0001 10	531 0063 10			
					530 0401 10	531 0063 11			
<b>Caribe</b>									
1.7L	77 - 87	L4, 8v, OHC			530 0001 10	531 0063 10			
					530 0401 10	531 0063 11			
<b>Corsar</b>									
1.8L	84 - 88	L4, 8v, OHC			530000110	531006310			
					530040110	531006311			
<b>Derby</b>									
1.8L	00 -	L4, 8v, OHC			530 0001 10	531 0063 10			
					530 0401 10	531 0063 11			
<b>Golf</b>									
A2 1.8L	89 - 92	L4, 8v, OHC			530 0401 10	531 0063 11			
A3 1.8L	92 - 99	L4, 8v, OHC			530 0401 10	531 0063 11			
A4 1.8L Turbo	01 - 05	L4, 20v, DOHC		530 0170 09	530 0170 10	531 0500 20	532 0312 20		
A4 2.0L	00 -	L4, 20v, DOHC			530 0171 10	531 0203 20			
<b>Jetta</b>									
A2 1.8L	88 - 92	L4, 8v, OHC			530 0401 10	531 0063 11			

				<b>SET</b>	<b>KIT</b>	<b>TENSORES Y POLEAS</b>			
--	--	--	--	------------	------------	--------------------------	--	--	--

**VOLKSWAGEN**
**Jetta**

A3 1.8L	93 - 99	L4, 8v, OHC			530 0401 10	531 0063 11			
A4 1.8L Turbo	00 - 05	L4, 20v, DOHC		530 0170 09	530 0170 10	531 0500 20	532 0312 20		
A4 1.8L Turbo	00 - 05	L4, 20v, DOHC			530 0417 10	531 0333 20			
A4 2.0L	99 - 05	L4, 8v, OHC			530 0171 10	531 0203 20			

**Lupo**

1.6L	05 -	L4, 8v, OHC		530 0089 09	530 0089 10	531 0317 10	531 0339 10	532 0167 10	532 0185 10
------	------	-------------	--	-------------	-------------	-------------	-------------	-------------	-------------

**New Beetle**

1.8L Turbo	00 - 05	L4, 20v, DOHC		530 0170 09	530 0170 10	531 0500 20	532 0312 20		
					530 0417 10	531 0333 20			
2.0L	98 -	L4, 8v, OHC			530 0171 10	531 0203 20			

**Passat**

1.8L Turbo	91 - 92	L4, 8v, OHC			530 0401 10	531 0063 11			
------------	---------	-------------	--	--	-------------	-------------	--	--	--

**Pointer**

1.8L	00 - 01	L4, 8v, OHC			530 0401 10	531 0063 11			
------	---------	-------------	--	--	-------------	-------------	--	--	--

**Polo**

1.6L	03 -	L4, 8v, OHC		530 0089 09	530 0089 10	531 0317 10	531 0339 10	532 0167 10	532 0185 10
------	------	-------------	--	-------------	-------------	-------------	-------------	-------------	-------------

**CAMIONETA (MINIVAN/VAN)**
**Combi**

1.8L	86 - 01	L4, 8v, OHC			530 0001 10	531 0063 10			
	86 - 01	L4, 8v, OHC			530 0401 10	531 0063 11			

**Eurovan**

1.9L	06 -	L4, 8v, OHV			530 0003 10	531 0079 10			
2.5L	01 - 04	L5, 10v, DOHC	Motor AAF/ACU/AEN/AEU (81-85KW) PGD		530 0155 10	531 0083 10			
			Motor AAF/ACU/AEN/AEU 81-85KW) PTD		530 0172 10	531 0278 30			

**Sharan**

1.8L	02 - 07	L4, 20v, DOHC		530 0170 09	530 0170 10	531 0500 20	532 0312 20		
------	---------	---------------	--	-------------	-------------	-------------	-------------	--	--





**VOLVO**
**C70**

2.3L Turbo	99 - 01	L5, 20Vv, DOHC		530 0063 09	530 0063 10	531 0312 10	532 0317 10		
------------	---------	----------------	--	-------------	-------------	-------------	-------------	--	--

**S40**

1.9L Turbo	99 - 04	L4, 16v, DOHC		530 006309	530 0063 10	531 0312 10	532 0317 10		
------------	---------	---------------	--	------------	-------------	-------------	-------------	--	--

## KITS Y SETS

				<b>SET</b>	<b>KIT</b>	<b>TENSORES Y POLEAS</b>			
---	---	---	---	------------	------------	--------------------------	--	--	--

### VOLVO

#### S60

2.4L Turbo	01 - 03	L5, 20v, DOHC		530 0063 09	530 0063 10	531 0312 10	532 031710		
------------	---------	---------------	--	-------------	-------------	-------------	------------	--	--

#### S70

2.3L Turbo	99 - 00	L5, 20v, DOHC		530 0044 09	530 0044 10	531 0090 10	532 0317 10		
------------	---------	---------------	--	-------------	-------------	-------------	-------------	--	--

2.4L Turbo	99 - 00	L5, 20v, DOHC		530 0063 09	530 0063 10	531 0312 10	532 0317 10		
------------	---------	---------------	--	-------------	-------------	-------------	-------------	--	--





#### V40

1.9L Turbo	99 - 04	L4, 16v, DOHC		530 0063 09	530 0063 10	531 0312 10	532 0317 10		
------------	---------	---------------	--	-------------	-------------	-------------	-------------	--	--



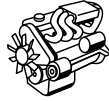

#### V70

2.3L Turbo	00 - 03	L5, 20v, DOHC		530 0044 09	530 0044 10	531 0090 10	532 0317 10		
				530 0063 09	530 0063 10	531 0312 10	532 0317 10		



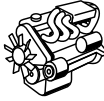

## LISTADO DE APLICACIONES POR No. DE PARTE

	SIGLAS		Lts.				
531 0003 10	PTA	BMW	M3	3.2L	02 - 03	L6, 24v, DOHC	Alternador / Bomba de agua / Dir. Hidráulica
			Z3	2.0L	2000	L4, 24v, (150 HP), DOHC	Alternador / Bomba de agua / Dir. Hidráulica
531 0004 10	PTA	BMW	750i	5.4L	95 - 01	V12, 48v, DOHC	Aire Acondicionado / Fan
531 0018 10	PTA	MERCEDES BENZ	Clase E 320	3.2L	96 - 97	L6, 24v, DOHC	
531 0019 10	PTD	FORD	Fiesta	1.3L	98 - 01	L4, 8v, OHV	
531 0020 10	PTD	FORD	Fiesta	1.4L	98 - 00	L4, 16v, DOHC	
				1.6L	01 - 04	L4, 8v, OHC	
531 0021 10	PTD	FORD	Contour	2.0L	96 - 98	L4, 16v, DOHC	
			Escort	1.8L	1995	L4, 16v, DOHC	
			Mondeo	2.0L	02 - 06	L4, 16v, DOHC	
			Mystique	2.0L	1995	L4, 16v, DOHC	
531 0030 10	PTD	PEUGEOT	206	1.4L	00 - 07	L4, 8v, OHC	
531 0047 10	PTD	PEUGEOT	306	2.0L	01 - 02	L4, 16v, OHC	
			406	2.0L	02 - 05	L4, 16v, DOHC	
531 0054 30	PTD	CHEVROLET	Astra	2.4L	04 - 06	L4, 16v, DOHC	
531 0063 10	PTD	VOLKSWAGEN	Atlantic	1.7L	77 - 87	L4, 8v, OHC	País de origen: Alemania
			Caribe	1.7L	77 - 87	L4, 8v, OHC	País de origen: Alemania
			Combi	1.8L	86 - 01	L4, 8v, OHC	País de origen: Alemania
			Corsar	1.8L	84 - 88	L4, 8v, OHC	País de origen: Alemania
			Golf A2	1.8L	89 - 92	L4, 8v, OHC	País de origen: Alemania
			Golf A3	1.8L	92 - 99	L4, 8v, OHC	País de origen: Alemania
			Jetta A2	1.8L	89 - 92	L4, 8v, OHC	País de origen: Alemania
			Jetta A3	1.8L	93 - 99	L4, 8v, OHC	País de origen: Alemania
531 0063 11	PTD	VOLKSWAGEN	Atlantic	1.7L	77 - 87	L4, 8v, OHC	País de origen: Brasil
			Caribe	1.7L	77 - 87	L4, 8v, OHC	País de origen: Brasil
			Combi	1.8L	86 - 01	L4, 8v, OHC	País de origen: Brasil
			Corsar	1.8L	84 - 88	L4, 8v, OHC	País de origen: Brasil
			Golf A2	1.8L	89 - 92	L4, 8v, OHC	País de origen: Brasil
			Golf A3	1.8L	92 - 99	L4, 8v, OHC	País de origen: Brasil
			Jetta A2	1.8L	89 - 92	L4, 8v, OHC	País de origen: Brasil
			Jetta A3	1.8L	93 - 99	L4, 8v, OHC	País de origen: Brasil
531 0079 10	PTD	VOLKSWAGEN	Eurovan Diesel	1.9L	06 -	L4, 8v, OHV	
531 0083 10	PTD	VOLKSWAGEN	Golf A3	1.8L	92 - 99	L4, 8v, OHC	
			Golf A3 Gti	2.0L	92 - 99	L4, 8v, OHC	
			Jetta A3	1.8L	93 - 99	L4, 8v, OHC	
			Jetta A3	2.0L	93 - 99	L4, 8v, OHC	

## LISTADO DE APLICACIONES POR No. DE PARTE



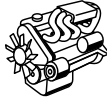

	SIGLAS		Lts.				
531 0090 10	PTD	VOLVO	S70 Turbo	2.4L	99 - 00	L5, 20v, DOHC	
			V70 Turbo	2.3L	00 - 03	L5, 20v, DOHC	
531 0095 10	PGA	BMW	Z3	1.9L	96 - 99	L4, 16v, (140 HP), DOHC	Aire Acondicionado
531 0096 10	PTA	PEUGEOT	405	2.0L	97 - 99	L4, 16v, DOHC	
531 0101 30	PTD	CHEVROLET	Chevy	1.4L	94 - 01	L4, 8v, OHC	Aire Acondicionado
				1.6L	96 - 03	L4, 8v, OHC	Aire Acondicionado
531 0118 20	PTD	CHRYSLER	Verna	1.6L	04 - 06	L4, 16v, DOHC	
531 0121 20	PGD	MITSUBISHI	Galant	2.4L	2004	L4, 16v, OHC	GDi EA3A / 4G64
531 0123 20	PTD	DODGE	H 100	2.4L	03 - 05	L4, 8v, OHC	
531 0131 20	PTD	HONDA	Accord	2.2L	96 - 97	L4, 16v, OHC	VTEC (CE9) / F2272
				2.3L	98 - 02	L4, 16v, OHC	VTEC (CE9) / F2272
531 0132 20	PTD	HONDA	Accord	2.2L	96 - 97	L4, 16v, OHC	VTEC (CE9) / F2272
				2.3L	98 - 02	L4, 16v, OHC	VTEC (CE9) / F2272
531 0177 20	PTD	TOYOTA	Camry	3.0L	02 - 04	V6, 24v, DOHC	1MZ-FE(140KW) / 3VZ-FE(138KW)
531 0181 20	PTD	TOYOTA	Corolla	1.8L	03 -	L4, 16v, DOHC	5A-FE, 4A-FE, 7A-FE / XE
531 0193 20	PTD	MITSUBISHI	Galant	2.4L	2004	L4, 16v, OHC	GDi EA3A / 4G64
531 0203 20	PTD	VOLKSWAGEN	Golf A4	2.0L	00 -	L4, 8v, OHC	1MZ-FE(140KW) / 3VZ-FE(138KW)
			Jetta A4	2.0L	99 - 05	L4, 8v, OHC	1MZ-FE(140KW) / 3VZ-FE(138KW)
			New Beetle	2.0L	98 -	L4, 8v, OHC	1MZ-FE(140KW) / 3VZ-FE(138KW)
531 0208 20	PTD	NISSAN	Hikari	1.6L	88 - 92	L4, 8v, OHC	
			Samurai	1.6L	86 - 87	L4, 8v, OHC	
			Tsubame	1.6L	87 - 91	L4, 8v, OHC	
			Tsuru I	1.5L	84 - 85	L4, 8v, OHC	
				1.6L	86 - 87	L4, 8v, OHC	
			Tsuru li	1.6L	88 - 91	L4, 8v, OHC	
Tsuru lii	1.6L	95 - 97	L4, 8v, OHC				
531 0214 20	PTD	INFINITI	I 30	3.0L	98 - 00	V6, 24v, DOHC	
		NISSAN	300 Zx	3.0L	91 - 96	V6, 24v, DOHC	
			Frontier	3.3L	01 - 04	V6, 12v, OHC	
			Maxima	3.0L	95 - 99	V6, 24v, DOHC	
			Quest	3.0L	97 - 98	V6, 12v, OHC	
			X Terra	2.4L	00 - 04	L4, 16v, DOHC	
			X Terra	3.3L	00 - 04	V6, 12v, OHC	
531 0241 10	PTD	PEUGEOT	306	1.6L	97 - 98	L4, 8v, OHC	
531 0251 30	PTD	VOLKSWAGEN	Eurovan Diesel	1.9L	06 -	L4, 8v, OHV	
531 0252 30	PTD	SEAT	Cordoba	1.6L	01 -	L4, 8v, OHC	
			Ibiza	1.6L	01 -	L4, 8v, OHC	
		VOLKSWAGEN	Derby	1.8L	00 -	L4, 8v, OHC	
			Polo	1.6L	03 -	L4, 8v, OHC	

## LISTADO DE APLICACIONES POR No. DE PARTE



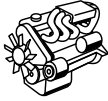

	SIGLAS		Lts.				
531 0258 10	PTA	PEUGEOT	406	2.0L	02 - 05	L4, 16v, DOHC	
				3.0L	00 - 02	V6, 24v, DOHC	
531 0265 10	PTA	PEUGEOT	306	1.8L	98 - 02	L4, 16v, OHC	
531 0267 10	PTA	BMW	540i	4.4L	97 - 03	V8, 32v, DOHC	
			740i	4.4L	01 - 01	V8, 32v, DOHC	
531 0273 30	PTD	CHEVROLET	Astra	2.0L	04 - 06	L4, 8v, OHC	TBT
531 0276 30	PTD	VOLKSWAGEN	Eurovan	2.5L	01 - 04	L5, 10v, DOHC	
531 0278 30	PTD	VOLKSWAGEN	Eurovan	2.5L	01 - 04	L5, 10v, DOHC	
531 0280 10	PTD	FIAT	Palio	1.6L	04 - 06	L4, 16v, DOHC	
531 0286 30	PTA	VOLKSWAGEN	Golf A4	1.8L	01 - 05	L4, 20v, DOHC	Alternador
				2.0L	00 -	L4, 8v, OHC	Alternador
			Jetta A3	1.8L	97 - 99	L4, 8v, OHC	Alternador
			Jetta A4	1.8L	98 - 99	L4, 8v, OHC	Alternador
				2.0L	97 - 06	L4, 8v, OHC	
531 0288 30	PTA	AUDI	A3	1.8 T	98 - 01	L4, 20v, DOHC	
		SEAT	Cordoba	1.6L	01 -	L4, 8v, OHC	
			Ibiza	1.6L	01 -	L4, 8v, OHC	
			Leon Turbo	1.8L	01 - 05	L4, 20v, DOHC	
			Toledo Turbo	1.8L	01 - 05	L4, 20v, DOHC	
		VOLKSWAGEN	Golf A4 Turbo	2.0L	00 -	L4, 8v, OHC	
			Jetta A4	2.0L	99 - 05	L4, 8v, OHC	
			New Beetle	2.0L	98 -	L4, 8v, OHC	
		531 0292 30	PTA	AUDI	A4	1.8 T	98 - 05
531 0298 30	PTA	CHEVROLET	Astra	2.2L	01 - 03	L4, 16v, DOHC	
			Chevy	1.6L	00 - 05	L4, 8v, OHC	
			Optra	2.0L	06 -	L4, 16v, DOHC	
			Vectra	2.2L	03 - 05	L4, 16v, DOHC	
			Zafira	2.2L	02 - 06	L4, 16v, DOHC	
531 0306 10	PTA	PEUGEOT	206	1.4L	00 -	L4, 8v, OHC	
531 0309 10	PTA	VOLKSWAGEN	Passat Turbo	1.8L	99 - 05	L4, 20v, DOHC	Aire Acondicionado
531 0312 10	PTD	VOLVO	C70 Turbo	2.3L	99 - 01	L5, 20v, DOHC	
			S40 Turbo	2.0L	99 - 04	L5, 20v, DOHC	
			S60 Turbo	2.0L	01 - 04	L5, 20v, DOHC	
				2.4L	01 - 03	L5, 20v, DOHC	
			S70 Turbo	2.4L	99 - 00	L5, 20v, DOHC	
V70 Turbo	2.3L	00 - 03	L5, 20v, DOHC				
531 0314 20	PTD	HONDA	Civic	1.6L	97 - 00	L4, 16v, OHC	
531 0317 10	PTD	VOLKSWAGEN	Lupo	1.6L	00 - 05	L4, 16v, DOHC	
			Polo	1.6L	00 - 05	L4, 16v, DOHC	
531 0322 10	PTA	BMW	525i	2.5L	01 - 03	L6, 24v, DOHC	





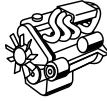

## LISTADO DE APLICACIONES POR No. DE PARTE

	SIGLAS		Lts.				
531 0326 10	PTD	CHRYSLER	Dart K	2.2L	82 - 89	L4, 8v, OHC	
			Lebaron K		82 - 88	L4, 8v, OHC	
			New Yorker		85 - 91	L4, 8v, OHC	
			Phantom	2.5L	90 - 94	L4, 8v, OHC	
			Volare K	2.2L	82 - 88	L4, 8v, OHC	
531 0333 20	PTD	AUDI	A4	1.8T	98 - 01	L4, 20v, DOHC	
		VOLKSWAGEN	Golf A4 Turbo	1.8L	01 - 06	L4, 20v, DOHC	
			Jetta A4		00 - 05	L4, 20v, DOHC	
			Passat Turbo		99 - 06	L4, 20v, DOHC	
531 0334 10	PTA	VOLVO	S60 Turbo	2.3L	01 - 03	L5, 20v, DOHC	
				2.9L	00 - 05	L6, 24v, DOHC	
			V70 Turbo	2.4L	99 - 03	L5, 20v, DOHC	
531 0339 10	PTD	VOLKSWAGEN	Lupo	1.6L	00 - 05	L4, 16v, DOHC	
			Polo			L4, 16v, DOHC	
531 0345 10	PTD	FORD	Contour	2.0L	98 - 00	L4, 16v, DOHC	
			Escort	1.9L	94 - 96	L4, 8v, OHC	
				2.0L	97 - 01	L4, 16v, DOHC	
			Focus	2.0L	00 - 03	L4, 16v, DOHC	
531 0346 10	PTA	BMW	323i	2.5L	97 - 01	L6, 24v, DOHC	Aire Acondicionado
			325i		02 - 04	L6, 24v, (170 - 190 HP), DOHC	Aire Acondicionado
			328i	2.8L	97 - 98	L6, 24v, DOHC	Aire Acondicionado
			330i	3.0L	01 - 04	L6, 24v, DOHC	Aire Acondicionado
			528i	2.8L	96 - 00	L6, 24v, DOHC	Aire Acondicionado
			M3	3.2L	00 - 03	L6, 24v, DOHC	Aire Acondicionado
			Z3	3.0L	01 - 02	L6, 24v, (228 HP), DOHC	Aire Acondicionado
531 0353 10	PTA	PEUGEOT	306	1.8L	98 - 02	L4, 16v, OHC	
531 0364 10	PTD	CHRYSLER	Lebaron K	2.2L	82 - 88	L4, 8v, OHC	
			Magnum K Turbo	5.7L	83 - 88	L4, 8v, OHC	
			Shadow Turbo	2.2L	89 - 90	L4, 8v, OHC	
531 0368 10	PTD	FORD	Ranger	2.3L	96 - 02	L4, 8v, OHC	
			Ranger	2.5L	98 - 01	L4, 8v, OHC	
531 0370 10	PTD	CHRYSLER	Concorde	3.5L	95 - 97	V6, 24v, OHC	
			Intrepid	3.5L	95 - 97	V6, 24v, OHC	
			Lebaron Lhs	3.5L	96 - 97	V6, 24v, OHC	
531 0371 10	PTD	CHRYSLER	Cirrus Turbo	2.4L	97 - 01	L4, 16v, DOHC	
			Neon	2.0L	95 - 99	L4, 16v, DOHC	
				2.4L	04 - 05	L4, 16v, OHC	
			Stratus Turbo	2.4L	95 - 01	L4, 16v, DOHC	



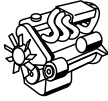

## LISTADO DE APLICACIONES POR No. DE PARTE

	SIGLAS		Lts.					
531 0380 10	PTD	AUDI	A6	4.2L	01 - 06	V8, 40v, DOHC	● 4B, C5, 4D2, 4D8	
			A6 Avant		01 - 06	V8, 40v, DOHC	● 4B, C5, 4D2, 4D8	
			A8		97 - 99	V8, 32v, DOHC	● 4D2, 4D8	
			S8		01 - 06	V8, 40v, DOHC		
			S8 Avant		01 - 06	V8, 40v, DOHC	● 4B, C5, 4D2, 4D8	
531 0409 30	PTD	NISSAN	Platina	1.6L	02 -	L4, 16v, DOHC		
		RENAULT	Clio		02 -	L4, 16v, DOHC		
531 0410 30	PTD	RENAULT	Clio Sport	2.0L	02 - 06	L4, 16v, DOHC		
			Megane		01 -	L4, 16v, DOHC		
531 0427 10	PTA	NISSAN	Platina	1.6L	02 -	L4, 16v, DOHC		
		RENAULT	Clio		02 -	L4, 16v, DOHC		
531 0429 20	PTA	CHRYSLER	Grand Voyager	3.8L	93 - 00	V6, 12v, OHV		
		CHRYSLER	Town & Country		93 - 00	V6, 12v, OHV		
		CHRYSLER	Voyager	3.3L	91 - 00	V6, 12v, OHV		
531 0430 10	PGA	CHEVROLET	Sierra	5.3L	2007	V8, 16v, OHV		
			Trail Blazer		02 -	V8, 32v, DOHC		
		CHRYSLER	D-150	3.9L	92 - 93	V6, 12v, OHV		
			Durango		5.2L	98 - 00	V8, 16v, OHV	
		DODGE	Ram 1500	3.9L	94 - 02	V6, 12v, OHV		
					95 - 03	V6, 12v, OHV		
					5.2L	97 - 02	V8, 16v, OHV	
			Ram 2500	5.9L	95 - 02	V8, 16v, OHV		
					8.0L	96 - 97	V10, 20v, OHV	
					5.2L	96 - 02	V8, 16v, OHV	
		Ram 2500 Van	5.9L	1994	V8, 16v, OHV			
		JEEP	Grand Cherokee	5.2L	93 - 98	V8, 16v, OHV		
					5.9L	1998	V8, 16v, OHV	
531 0430 20	PTA	CHRYSLER	Durango	5.9L	99 - 03	V8, 16v, OHV		
		DODGE	Ram 1500	3.9L	94 - 02	V6, 12v, OHV		
			Ram 3500 Maxi Wagon	5.9L	95 - 02	V8, 16v, OHV		
			Ram 4000	5.9L	2002	V8, 16v, OHV		
		JEEP	Cherokee	4.0L	96 - 01	L6, 12v, OHV		
JEEP	Grand Cherokee	5.2L	95 - 98	V8, 16v, OHV				
531 0431 30	PTA	FORD	Mustang Cobra	5.0L	79 - 94	V8, 16v, OHV		
			Mustang Gt		79 - 94	V8, 16v, OHV		



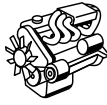

## LISTADO DE APLICACIONES POR No. DE PARTE

	SIGLAS		Lts.				
531 0433 20	PTA	FORD	F-150	4.9L	95 - 97	L6, 12v, OHC	
			F-200	5.0L	87 - 92	V8, 16v, OHV	
			F-350	4.9L	1995	V8, 16v, OHC	
			F-350	5.0L	86 - 94	V8, 16v, OHC	
			Mustang Cobra	5.0L	79 - 94	V8, 16v, OHV	
		LINCOLN	Continental	4.6L	97 - 99	V8, 32v, DOHC	
			Continental	4.6L	97 - 99	V8, 32v, DOHC	
531 0434 30	PTA	FORD	Cougar	3.8L	85 - 94	V6, 12v, OHV	
			Thunderbird	3.8L	85 - 94	V6, 12v, OHC	
531 0435 30	PTA	FORD	Escort	1.8L	1995	L4, 16v, DOHC	
			Escort	1.9L	94 - 96	L4, 8v, OHC	
531 0436 20	PTD	VOLKSWAGEN	Bora Diesel	1.9L	2007	L4, 8v, OHC	
531 0437 30	PTA	FORD	Expedition	5.4L	97 - 01	V8, 16v, OHC	Triton
			F-450	6.8L	98 - 04	V10, 20v, OHV	Triton
			F-550	6.8L	03 - 05	V10, 20v, OHV	Triton
531 0438 30	PTA	FORD	F-450	7.3L	00 - 03	V8, 16v, OHV	
			F-450	7.5L	97 - 98	V8, 16v, OHV	
531 0439 20	PTA	VOLKSWAGEN	Pointer	1.8L	98 - 00	L4, 8v, OHV	Aire Acondicionado
			Pointer	1.8L	00 - 06	L4, 8v, OHC	Aire Acondicionado
			Pointer	2.0L	00 - 03	L4, 8v, OHC	Aire Acondicionado
531 0440 20	PTA	VOLKSWAGEN	Pointer	1.8L	98 - 00	L4, 8v, OHV	Aire Acondicionado, Dir. Hidráulica
			Pointer	1.8L	00 - 06	L4, 8v, OHC	Aire Acondicionado, Dir. Hidráulica
			Pointer	2.0L	00 - 03	L4, 8v, OHC	Aire Acondicionado, Dir. Hidráulica
531 0440 30	PTD	VOLKSWAGEN	Eurovan Diesel	1.9L	06 -	L4, 8v, OHV	
531 0441 20	PTA	FORD	Explorer	4.0L	91 - 01	V6, 12v, OHC	
531 0442 30	PTA	FORD	Escort	2.0L	97 - 01	L4, 16v, DOHC	
531 0443 30	PTA	FORD	Econoline E-150	4.2L	97 - 03	V6, 12v, OHV	
531 0444 30	PTA	FORD	Econoline E-250	4.2L	97 - 98	V6, 12v, OHV	
			Econoline E-350	5.4L	98 - 99	V8, 16v, OHC	
531 0445 20	PTA	CADILLAC	Deville	4.9L	91 - 95	V8, 16v, OHV	
			Seville	4.9L	1994	V8, 16v, OHV	
531 0446 10	PTA	CHEVROLET	G 20	4.3L	94 - 95	V6, 16v, OHV	Sin Aire Acondicionado
			P 30	5.7L	92 - 96	V8, 16v, OHC	
531 0446 20	PTA	CHEVROLET	Express Van 2500	5.7L	97 - 02	V8, 16v, OHV	Sin Aire Acondicionado
531 0447 20	PTA	CHEVROLET	Express Van 2500	5.7L	97 - 02	V8, 16v, OHV	Aire Acondicionado



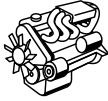

## LISTADO DE APLICACIONES POR No. DE PARTE

	SIGLAS		Lts.				
531 0448 20	PTA	CHEVROLET	Blazer	4.3L	95 - 01	V6, 12v, OHV	Aire Acondicionado
			C 1500	4.3L	99 - 02	V6, 12v, OHC	Aire Acondicionado
			C 1500 Silverado	4.3L	03 - 06	V6, 12v, OHC	Aire Acondicionado
			C 2500 Cheyenne	5.7L	95 - 02	V8, 16v, OHV	Aire Acondicionado
			C 3500	5.7L	95 - 04	V8, 16v, OHC	Aire Acondicionado
			P 30	5.7L	97 - 02	V8, 16v, OHV	
			S 10	4.3L	98 - 99	V6, 12v, OHV	Aire Acondicionado
			Suburban	5.7L	95 - 02	V8, 16v, OHV	Aire Acondicionado
531 0449 20	PTA	CHEVROLET	Corvette	5.7L	91 - 96	V8, 16v, OHV	
		PONTIAC	Firebird	5.7L	94 - 01	V8, 16v, OHV	
531 0450 20	PTA	CHEVROLET	Express 3500	5.7L	97 - 02	V8, 16v, OHV	
			Express Van 1500	4.3L	00 - 03	V6, 12v, OHV	
531 0451 20	PTA	CHEVROLET	Blazer	4.3L	95 - 01	V6, 12v, OHV	
			C 1500 Silverado	4.3L	03 - 06	V6, 12v, OHC	
			C 2500 Cheyenne	5.7L	93 - 02	V8, 16v, OHC	
			C 3500 Hd	7.4L	96 - 01	V8, 16v, OHV	Vortec
			C 3500 Silverado	5.7L	95 - 99	V8, 16v, OHV	
			S 10	4.3L	98 - 99	V6, 12v, OHV	
			Suburban	5.7L	96 - 99	V8, 16v, OHV	
531 0452 20	PTA	CHEVROLET	Malibu	3.1L	97 - 03	V6, 12v, OHV	
			Venture	3.4L	97 - 04	V6, 12v, OHV	
		PONTIAC	Aztek	3.4L	01 - 05	V6, 12v, OHV	
			Grand Am	3.4L	94 - 01	V6, 12v, OHV	
			Sunfire	2.4L	97 - 01	L4, 16v, DOHC	
531 0453 20	PTA	CHEVROLET	Impala	3.8L	00 - 03	V6, 12v, OHV	
			Lumina	3.8L	95 - 96	V6, 12v, OHV	
		PONTIAC	Bonneville	3.8L	95 - 99	V6, 12v, OHV	
531 0454 20	PTA	CHEVROLET	Cavalier	2.2L	95 - 00	L4, 8v, OHV	
			Cavalier	2.4L	99 - 01	L4, 16v, DOHC	
531 0455 20	PTA	PONTIAC	Sunfire	2.4L	97 - 01	L4, 16v, DOHC	
531 0456 20	PTA	CHEVROLET	Celebrity	2.8L	82 - 89	V6, 12v, OHV	
			Century	2.8L	83 - 94	V6, 12v, OHV	
			Citation	2.8L	82 - 86	V6, 12v, OHV	
			Cutlass	2.8L	87 - 88	V6, 12v, OHV	
			Cutlass	3.1L	89 - 96	V6, 12v, OHV	

## LISTADO DE APLICACIONES POR No. DE PARTE

	SIGLAS		Lts.				
531 0456 20	PTA	CHEVROLET	Impala	3.4L	00 - 07	V6, 12v, OHV	
			Regal	3.8L	95 - 96	V6, 12v, OHV	
			Venture	3.4L	97 - 04	V6, 12v, OHV	
531 0457 20	PTA	JEEP	Grand Cherokee	4.0L	95 - 02	L6, 12v, OHV	
			Grand Cherokee	5.2L	95 - 98	V8, 16v, OHV	
			Wrangler	4.0L	95 - 96	L6, 12v, OHV	
531 0459 20	PTA	FORD	Taurus	3.8L	98 - 91	V6, 12v, OHC	
			Windstar	3.8L	98 - 03	V6, 12v, OHV	
531 0460 20	PTA	FORD	Cougar	4.9L	91 - 95	V8, 12v, OHC	
			Crown Victoria	4.6L	1981	V8, 16v, OHC	
			Grand Marquis	4.6L	92 - 00	V8, 16v, OHC	
			Grand Marquis	4.6L	92 - 04	V8, 16v, OHC	
			Thunderbird	4.6L	95 - 96	V8, 16v, OHC	
			Thunderbird	5.0L	90 - 94	V8, 16v, OHC	
		LINCOLN	Mark Viii	4.6L	95 - 96	V8, 32v, DOHC	
Town Car	4.6L	92 - 99	V8, 16v, OHC				
531 0461 20	PTA	FORD	Ranger	3.0L	96 - 01	V6, 12v, OHV	
			Sable	3.0L	96 - 04	V6, 24v, DOHC	
531 0462 20	PTA	FORD	F-250	5.4L	99 - 06	V8, 16v, OHC	Triton
			F-250	5.8L	94 - 98	V8, 16v, OHC	Triton
			F-350	5.4L	99 - 05	V8, 16v, OHC	
			F-350	5.8L	93 - 98	V8, 16v, OHC	
531 0463 20	PTA	FORD	F-250	5.4L	99 - 04	V8, 16v, OHC	Triton
			F-250	5.8L	94 - 98	V8, 16v, OHC	Triton
			F-350	5.4L	99 - 05	V8, 16v, OHC	Triton
			F-350	5.8L	93 - 98	V8, 16v, OHC	
531 0478 10	PTD	PEUGEOT	206	1.6L	01 - 07	L4, 16v, DOHC	
531 0479 10	PGD	PEUGEOT	307	2.0L	03 -	L4, 16v, DOHC	
			406	2.0L	02 - 05	L4, 16v, DOHC	
531 0487 30	PTA	CHRYSLER	Crossfire	3.2L	04 - 06	V6, 18v, OHC	
			MERCEDES BENZ	Clase C 260	2.6L	00 - 02	V6, 18v, OHC
		Clase C 320		3.2L	01 - 02	V6, 18v, OHC	
		Clase C 43		4.3L	99 - 00	V8, 32v, OHC	
		Clase Cl 500		5.0L	02 - 04	V8, 24v, OHC	
		Clase Clk 320		3.2L	97 - 05	V6, 18v, OHC	
		Clase Clk 430	4.3L	99 - 02	V8, 24v, OHC		

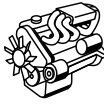



## LISTADO DE APLICACIONES POR No. DE PARTE

	SIGLAS		Lts.				
531 0487 30	PTA	MERCEDES BENZ	Clase E 320	3.2L	98 - 01	V6, 18v, OHC	
			Clase E 430	4.3L	98 - 02	V8, 24v, OHC	
			Clase E 55	5.5L	99 - 01	V8, 24v, OHC	
			Clase G 500	5.0L	02 - 05	V8, 24v, OHC	
			Clase MI 320	3.2L	98 - 03	V6, 18v, OHV	
			Clase MI 430	4.3L	98 - 01	V8, 24v, OHC	
			Clase MI 500	5.0L	02 - 06	V8, 24v, OHC	
			Clase MI 55	5.5L	2001	V8, 24v, OHC	
			Clase S 430	4.3L	99 - 04	V8, 24v, OHC	
			Clase S 500	5.0L	00 - 02	V8, 24v, OHC	
			Clase SI 500	5.0L	99 - 01	V8, 24v, OHC	
			Clase Slk 320	3.2L	01 - 04	V6, 18v, OHC	
531 0488 30	PTA	MERCEDES BENZ	Clase E 320	3.2L	96 - 97	L6, 24v, DOHC	
			Clase SI 320	3.2L	96 -97	L6, 24v, DOHC	
531 0490 30	PTA	AUDI	A4	2.8L	97 - 01	V6, 30v, (193 HP), DOHC	
			A6	2.7L	00 - 05	V6, 30v, DOHC	
			A6	2.8L	98 - 01	V6, 30v, DOHC	
			Cabriolet	2.8L	97 - 98	V6, 24v, DOHC	
			S4	2.7L	00 - 01	V6, 30v, DOHC	
		VOLKSWAGEN	Passat	2.8L	99 - 05	V6, 24v, DOHC	
531 0500 20	PTD	AUDI	A3	1.8 T	98 - 01	L4, 20v, DOHC	
			S3	1.8L	2000	L4, 20v, DOHC	
			Tt	1.8 T	99 - 00	L4, 20v, (150 HP), DOHC	
		SEAT	Alhambra Turbo	1.8L	02 -	L4, 20v, DOHC	
			Leon Turbo	1.8L	01 - 05	L4, 20v, DOHC	
			Toledo Turbo	1.8L	01 - 05	L4, 20v, DOHC	
		VOLKSWAGEN	Golf A4	1.8L	01 - 05	L4, 20v, DOHC	
			Jetta A4	1.8L	00 - 05	L4, 20v, DOHC	
			New Beetle Turbo	1.8L	00 - 05	L4, 20v, DOHC	
			Sharan Turbo	1.8L	02 -	L4, 20v, DOHC	
531 0518 30	PTD	CHEVROLET	Astra	1.8L	00 - 06	L4, 16v, DOHC	
			Corsa	1.8L	03 -	L4, 8v, OHC	
			Tigra	1.6L	1999	L4, 16v, DOHC	
			Zafira	1.8L	02 - 05	L4, 16v, DOHC	

## LISTADO DE APLICACIONES POR No. DE PARTE

	SIGLAS		Lts.				
531 0521 30	PTA	CHEVROLET	Cavalier	2.2L	01 - 04	L4, 8v, OHV	
			Hhr	2.4L	06 -	L4, 16v, DOHC	
			Malibu	2.2L	04 - 06	L4, 16v, DOHC	
			Vectra	2.2L	03 - 05	L4, 16v, DOHC	
			Zafira	2.2L	02 - 06	L4, 16v, DOHC	
531 0531 20	PTD	AUDI	A4	1.8 T	00 - 02	L4, 20v, DOHC	
531 0537 30	PTA	VOLKSWAGEN	Passat Turbo	1.8L	99 - 01	L4, 20v, DOHC	
531 0541 10	PTA	FORD	Fiesta	1.4L	98 - 00	L4, 16v, DOHC	
531 0546 10	PTD	PEUGEOT	307	2.0L	03 -	L4, 16v, DOHC	Motor RFN (EW10J4) 100 kw
531 0560 00	PTA	CADILLAC	Catera	3.0L	97 - 01	V6, 24v, DOHC	
			Cts	3.2L	2003	V6, 24v, (220 HP), DOHC	
		CHEVROLET	Vectra	3.2L	03 - 05	V6, 24v, DOHC	
531 0563 00	PTA	MERCEDES BENZ	Clase C 220	2.2L	95 - 97	L4, 16v, DOHC	
			Clase C 230	2.3L	97 - 98	L4, 16v, DOHC	
			Clase S1k 230	2.3L	97 - 00	L4, 16v, DOHC	
531 0566 40	PTD	CHRYSLER	Neon	2.0L	99 - 05	L4, 16v, OHC	Con base de aluminio
			Neon	2.4L	99 - 05	L4, 16v, OHC	Con base de aluminio
			Pt Cruiser	2.4L	01 -	L4, 16v, DOHC	Con base de aluminio
			Stratus	2.4L	02 - 04	L4, 16v, DOHC	Con base de aluminio
		JEEP	Wrangler	2.4L	03 - 06	L4, 8v, OHV	Con base de aluminio
531 0567 00	PTD	CHRYSLER	Breeze	2.4L	1996	L4, 16v, (150 HP), DOHC	
			Cirrus Turbo	2.4L	97 - 01	L4, 16v, DOHC	
			Stratus	2.4L	2002	L4, 16v, DOHC	
531 0568 00	PTA	CHRYSLER	Pt Cruiser	2.4L	01 -	L4, 16v, DOHC	Aire Acondicionado, Dir. Hidráulica
531 0585 20	PTD	CHRYSLER	Atos	1.0L	01 - 04	L4, 12v, OHC	
				1.1L	05 -	L4, 12v, OHC	
531 0586 10	PTD	FORD	Fiesta	1.4L	98 - 00	L4, 16v, DOHC	
531 0647 20	PTD	HONDA	Accord	3.0L	98 - 02	V6, 24v, OHV	K9
531 0793 10	CHRYSLER	DODGE	D-150	3.9L	92 - 93	V6, 12v, OHV	
			Durango	5.2L	98 - 00	V8, 16v, OHV	
			Durango	5.9L	99 - 03	V8, 16v, OHV	
	DODGE	Ram 1500	3.9L	94 - 02	V6, 12v, OHV		
		Ram 1500 Van	3.9L	95 - 03	V6, 12v, OHV		
		Ram 2500	5.2L	97 - 02	V8, 16v, OHV		
		Ram 2500	5.9L	95 - 02	V8, 16v, OHV		
		Ram 2500 Van	5.2L	96 - 02	V8, 16v, OHV		
		Ram Charger	5.9L	1994	V8, 16v, OHV		
		JEEP	Grand Cherokee	5.2L	93 - 98	V8, 16v, OHV	

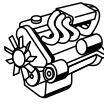



## LISTADO DE APLICACIONES POR No. DE PARTE

	<b>SIGLAS</b>		<b>Lts.</b>			
--	---------------	---	-------------	---	---	---



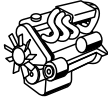

531 0794 10	PGD	CADILLAC	Deville	4.9L	91 - 95	V8, 16v, OHV	
			Cavalier	2.8L	90 - 94	V6, 12v, OHV	
			Cavalier Z24	3.1L	91 - 94	V6, 12v, OHV	
			Celebrity	2.8L	87 - 89	V6, 12v, OHV	
			Century	2.8L	94 - 96	V6, 12v, OHV	
			Cutlass Eurosport	2.8L	87 - 88	V6, 12v, OHV	
			Cutlass Eurosport	3.1L	89 - 96	V6, 12v, OHV	
			Eighty Eight	3.8L	1995	V6, 12v, OHV	
			Impala	3.8L	00 - 03	V6, 12v, OHV	
			Lumina Apv	3.1L	95 - 96	V6, 12v, OHV	
			Venture	3.4L	97 - 04	V6, 12v, OHV	
		FORD	Bronco	5.0L	91 - 96	V8, 16v, OHC	
			Bronco	5.8L	91 - 96	V8, 16v, OHC	
			Cougar	3.8L	85 - 94	V6, 12v, OHV	Versión XR-7
			Cougar	3.8L	89 - 90	V6, 12v, OHV	
			Econoline Van	4.2L	97 - 03	V6, 12v, OHV	
			Explorer	5.0L	95 - 96	V8, 16v, OHV	
			F-150	4.2L	98 - 05	V6, 12v, OHV	
			F-250	5.0L	96 - 97	V8, 16v, OHC	
			F-250	5.8L	92 - 97	V8, 16v, OHC	
			F-350	5.8L	1988	V8, 16v, OHC	
			Taurus	3.8L	98 - 91	V6, 12v, OHC	
			Thunderbird	3.8L	89 - 94	V6, 12v, OHC	
			Thunderbird	5.0L	91 - 94	V8, 16v, OHC	
		PONTIAC	Boneville	3.8L	95 - 99	V6, 12v, OHV	
			Grand Prix	3.1L	97 - 98	V6, 12v, OHV	
			Grand Prix	3.8L	97 - 97	V6, 24v, DOHC	
			Grand Prix	3.8L	97 - 01	V6, 12v, OHV	
PGA	CHEVROLET	Cavalier	2.4L	96 - 01	L4, 16v, DOHC		
		Malibu	2.4L	97 - 99	L4, 16v, DOHC		
	FORD	Topaz	2.3L	92 - 94	L4, 8v, OHC	Aire Acondicionado	
PGD	PONTIAC	Sunfire	2.4L	97 - 01	L4, 16v, DOHC		
	PGD	FORD	Tracker	2.0L	99 - 04	L4, 16v, DOHC	
			Econoline Van	5.4L	98 - 01	V8, 16v, OHC	
Econoline Van			6.8L	97 - 01	V10, 20v, OHC		
F-250			4.6L	97 - 01	V8, 16v, OHC		
F-250			5.4L	99 - 01	V8, 16v, OHC		
F-350	5.4L	99 - 01	V8, 16v, OHC				



## LISTADO DE APLICACIONES POR No. DE PARTE

	SIGLAS		Lts.				
531 0798 10	PGD	CHEVROLET	Colorado	2.8L	04 - 06	L4, 16v, DOHC	
			Colorado	3.5L	04 - 06	L5, 20v, DOHC	
			Trail Blazer	4.2L	02 -	L6, 24v, DOHC	
		HUMMER	H3	3.5L	2006	L5, 20v, DOHC	
531 0799 10	PGA	FORD	Grand Marquis	4.6L	00 - 04	V8, 16v, OHC	
			Mustang	4.6L	00 - 04	V8, 16v, OHC	
		LINCOLN	Town Car	4.6L	00 - 05	V8, 16v, OHC	
531 0800 10	PTA	CHEVROLET	S 10	2.2L	94 - 98	L4, 8v, OHV	
531 1133 71	PGA		Corsa	1.8L	03 -	L4, 8v, OHC	Aire Acondicionado, Dir. Hidráulica
531 2201 10	PTHA	CHRYSLER	Pt Cruiser	2.4L	01 -	L4, 16v, DOHC	
532 0001 10	PGA	BMW	323i	2.5L	97 - 01	L6, 24v, DOHC	Alternador / Bomba agua / Dir. Hidráulica
			325i	2.5L	02 - 04	L6, 24v, (170 - 190 HP), DOHC	
			328i	2.8L	97 - 98	L6, 24v, DOHC	
			330i	3.0L	01 - 04	L6, 24v, DOHC	
			528i	2.8L	96 - 01	L6, 24v, DOHC	
			M3	3.2L	00 - 03	L6, 24v, DOHC	
			Z3	3.0L	01 - 02	L6, 24v, (228 HP), DOHC	
532 0016 10	PGD	FORD	Contour	2.5L	96 - 00	V6, 24v, DOHC	
			Mondeo	2.5L	02 - 04	V6, 24v, DOHC	
			Mystique	2.5L	95 - 00	V6, 24v, DOHC	
532 0020 10	PGD	PEUGEOT	406	2.0L	02 - 05	L4, 16v, DOHC	
532 0028 10	PGA	MERCEDES BENZ	Clase S 600	6.0L	96 - 98	V12, 48v, DOHC	
			Clase SI 600	6.0L	96 - 98	V12, 48v, DOHC	
532 0030 10	PGA	MERCEDES BENZ	Clase S 500	5.0L	96 - 98	V8, 32v, DOHC	
			Clase SI 500	5.0L	96 - 98	V8, 32v, DOHC	
532 0031 10	PGA	MERCEDES BENZ	Clase S 500	5.0L	96 - 98	V8, 32v, DOHC	
			Clase SI 500	5.0L	96 - 98	V8, 32v, DOHC	
532 0033 10	PGD	CHEVROLET	Astra	1.8L	00 - 06	L4, 16v, DOHC	
			Corsa	1.8L	03 -	L4, 8v, OHC	
			Meriva	1.8L	04 - 05	L4, 16v, OHC	
			Zafira	1.8L	02 - 05	L4, 16v, DOHC	
532 0034 10	PGD	CHEVROLET	Corsa	1.4L	02 - 03	L4, 16v, DOHC	
532 0039 10	PGD	CHEVROLET	Corsa	1.4L	02 - 03	L4, 16v, DOHC	
532 0040 10	PGD	CHEVROLET	Astra	2.0L	04 - 06	L4, 8v, OHC	
532 0051 10	PGD	VOLKSWAGEN	Eurovan	2.5L	01 - 04	L5, 10v, DOHC	
532 0059 10	PGA	BMW	325i	2.5L	02 - 04	L6, 24v, (170 - 190 HP), DOHC	
			525i	2.5L	01 - 03	L6, 24v, DOHC	

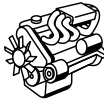



## LISTADO DE APLICACIONES POR No. DE PARTE

	SIGLAS		Lts.				
532 0066 10	PGA	AUDI	A6	4.2L	01 - 05	V8, 40v, DOHC	
			A8	3.7L	00 - 01	V8, 40v, DOHC	
			A8	4.2L	97 -	V8, 40v, DOHC	
			A8 Quattro	4.2L	99 - 01	V8, 32v, DOHC	
			Rs6	4.2L	2004	V8, 40v, DOHC	
			S6	4.2L	01 - 04	V8, 40v, DOHC	
			S8	4.2L	01 - 02	V8, 40v, DOHC	
532 0067 10	PGA	VOLKSWAGEN	Cabrio	2.0L	96 - 02	L4, 8v, OHC	Alternador
			Eurovan	2.5L	01 - 04	L5, 10v, DOHC	Alternador
			Golf A3	1.8L	92 - 99	L4, 8v, OHC	
			Golf A3	2.0L	93 - 99	L4, 8v, OHC	
			Golf A4	1.8L	01 - 05	L4, 20v, DOHC	Alternador
			Golf A4	2.0L	00 -	L4, 8v, OHC	Alternador
			Jetta A3	1.8L	93 - 99	L4, 8v, OHC	Alternador
			Jetta A3	2.0L	93 - 99	L4, 8v, OHC	Alternador
			Jetta A4	1.8L	00 - 05	L4, 20v, DOHC	Alternador
			Jetta A4	2.0L	99 - 05	L4, 8v, OHC	
			New Beetle	2.0L	98 -	L4, 8v, OHC	Alternador
			New Beetle Turbo	1.8L	00 - 05	L4, 20v, DOHC	Alternador
			Pointer	1.8L	98 - 00	L4, 8v, OHV	Alternador
			Pointer	1.8L	00 - 06	L4, 8v, OHC	Alternador
			Pointer	2.0L	00 - 03	L4, 8v, OHC	Alternador
Polo	1.6L	03 -	L4, 8v, OHC	Alternador			
Sharan Turbo	1.8L	02 -	L4, 20v, DOHC	Alternador			
532 0074 20	PGD	MITSUBISHI	Galant	2.4L	04 - 06	L4, 16v, OHC	
			Lancer	2.0L	04 - 06	L4, 16v, OHC	
532 0087 10	PGD	CHEVROLET	Astra	2.4L	04 - 06	L4, 16v, DOHC	
532 0092 20	PGD	TOYOTA	Camry	3.0L	02 - 04	V6, 24v, DOHC	1MZ-FE(140KW) / 3VZ-FE(138KW)
532 0093 10	PGD	FORD	Contour	2.0L	96 - 00	L4, 16v, DOHC	
			Mystique	2.0L	1995	L4, 16v, DOHC	
532 0109 10	PGA	CHEVROLET	Chevy	1.6L	94 - 00	L4, 8v, OHC	Aire Acondicionado, Dir. Hidráulica
532 0111 10	PGD	VOLKSWAGEN	Bora Diesel	1.9L	06 -	L4, 8v, OHC	
532 0120 10	PGD	ALFA ROMEO	147	2.0L	02 - 05	L4, 16v, (150 HP), DOHC	
			156	2.0L	02 - 04	L4, 16v, (150 HP), DOHC	
532 0123 10	PGA	PEUGEOT	306	2.0L	01 - 02	L4, 16v, OHC	
			406	2.0L	02 - 05	L4, 16v, DOHC	
532 0124 10	PGA	PEUGEOT	406	2.0L	02 - 05	L4, 16v, DOHC	
532 0132 20	PTD	HONDA	Accord	2.3L	98 - 02	L4, 16v, OHC	



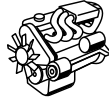

## LISTADO DE APLICACIONES POR No. DE PARTE

	SIGLAS		Lts.				
532 0138 10	PGA	PEUGEOT	405	2.0L	97 - 99	L4, 16v, DOHC	
532 0139 10	PGA	PEUGEOT	306	1.8L	98 - 00	L4, 8v, OHC	
			306	1.8L	98 - 02	L4, 16v, OHC	
532 0142 10	PGD	PEUGEOT	206	1.6L	01 - 07	L4, 16v, DOHC	
532 0143 10	PGA	RENAULT	Clio	2.0L	02 - 06	L4, 16v, DOHC	
			Megane	2.0L	01 -	L4, 16v, DOHC	
532 0150 10	PGA	VOLKSWAGEN	Eurovan	2.5L	01 - 04	L5, 10v, DOHC	Aire Acondicionado, Alternador
532 0151 10	PGD	FORD	Contour	2.0L	96 - 00	L4, 16v, DOHC	
			Escort	1.9L	94 - 96	L4, 8v, OHC	
			Focus	2.0L	00 - 03	L4, 16v, DOHC	
			Mystique	2.0L	1995	L4, 16v, DOHC	
532 0152 10	PGA	FORD	Escort	1.9L	94 - 96	L4, 8v, OHC	
			Focus	2.0L	00 - 03	L4, 16v, DOHC	
532 0159 10	PGD	AUDI	A4	2.8L	96 - 01	V6, 30v, (193 HP), DOHC	AGA, AGJ,ACK
		VOLKSWAGEN	Passat	2.8L	02 - 05	V6, 30v, DOHC	AGA, AGJ,ACK motion
532 0160 10	PGA	MERCEDES BENZ	Clase C 280	2.8L	95 - 98	L6, 24v, DOHC	
			Clase CI 500	5.0L	97 - 99	V8, 32v, DOHC	
			Sprinter	2.1L	07 -	L4, 16v, OHC	
532 0161 10	PGD	AUDI	A4	1.8 T	98 - 01	L4, 20v, DOHC	
		SEAT	Alhambra Turbo	1.8L	02 -	L4, 20v, DOHC	
			Leon Turbo	1.8L	01 - 05	L4, 20v, DOHC	
			Toledo Turbo	1.8L	01 - 05	L4, 20v, DOHC	
		VOLKSWAGEN	Golf A4	2.0L	00 -	L4, 8v, OHC	
			Jetta A4	2.0L	99 - 05	L4, 8v, OHC	
		New Beetle	2.0L	98 -	L4, 8v, OHC		
532 0162 10	PGA	VOLKSWAGEN	Eurovan	2.5L	01 - 04	L5, 10v, DOHC	
532 0167 10	PGD	VOLKSWAGEN	Lupo	1.6L	05 -	L4, 8v, OHC	
			Polo	1.6L	03 -	L4, 8v, OHC	
532 0169 10	PGA	VOLKSWAGEN	Eurovan	2.5L	01 - 04	L5, 10v, DOHC	Dir. Hidráulica
532 0180 20	PGD	CHEVROLET	Corsa	1.8L	03 -	L4, 8v, OHC	
532 0185 10	PGD	VOLKSWAGEN	Lupo	1.6L	05 -	L4, 8v, OHC	
			Polo	1.6L	03 -	L4, 8v, OHC	
532 0187 10	PGA	FORD	Fiesta	1.3L	98 - 01	L4, 8v, OHV	
532 0209 10	PGD	FIAT	Palio	1.6L	04 - 06	L4, 16v, DOHC	
532 0221 10	PGD	NISSAN	Platina	1.6L	02 -	L4, 16v, DOHC	
		RENAULT	Clio	1.6L	02 -	L4, 16v, DOHC	
			Laguna	2.0L	2006	L4, 16v, DOHC	
			Megane	2.0L	01 -	L4, 16v, DOHC	

## LISTADO DE APLICACIONES POR No. DE PARTE

	SIGLAS		Lts.				
532 0227 10	PGD	CHRYSLER	Cirrus	2.4L	97 - 00	L4, 16v, DOHC	
			Neon	2.0L	95 - 99	L4, 16v, DOHC	
			Stratus	2.4L	95 - 00	L4, 16v, DOHC	
532 0229 10	PGA	FIAT	Palio	1.6L	04 - 06	L4, 16v, DOHC	
532 0233 10	PGA	MERCEDES BENZ	Clase Cl 600	6.0L	97 - 99	V8, 32v, DOHC	
532 0234 10	PGA	MERCEDES BENZ	Clase Cl 600	5.5L	03 - 05	V12, 36v, DOHC	
			Clase Cl 600	5.8L	01 - 03	V12, 36v, DOHC	
			Clase Cl Amg 65	6.0L	2005	V12, 36v, OHC	
			Clase S 600	5.5L	03 - 05	V12, 36v, OHC	
			Clase S 600	5.8L	02 - 03	V12, 36v, OHC	
			Clase S 600	6.0L	2005	V12, 36v, OHC	
532 0242 10	PGA	VOLVO	C70 Turbo	2.3L	99 - 01	L5, 20v, DOHC	
			S40 Turbo	2.0L	99 - 04	L5, 20v, DOHC	
			S60 Turbo	2.0L	01 - 04	L5, 20v, DOHC	
			S60 Turbo	2.4L	01 - 03	L5, 20v, DOHC	
			S70 Turbo	2.4L	99 - 00	L5, 20v, DOHC	
			V70 Turbo	2.3L	00 - 03	L5, 20v, DOHC	
532 0243 10	PGA	NISSAN	Platina	1.6L	02 -	L4, 16v, DOHC	
		RENAULT	Clio	1.6L	02 -	L4, 16v, DOHC	
532 0254 10	PGA	FORD	Fiesta	1.3L	98 - 01	L4, 8v, OHV	
532 0261 10	PGA	CHRYSLER	Concorde	3.5L	95 - 02	V6, 24v, OHC	Con buje de 12mm.
			D-150	3.7L	83 - 92	L6, 12v, OHC	Con buje de 12mm, Aire Acondicionado
			Dakota	2.5L	1996	L4, 8v, OHC	Con buje de 12mm, Aire Acondicionado
			Dart K	2.2L	82 - 89	L4, 8v, OHC	Con buje de 12mm, Aire Acondicionado
			Lebaron K	2.2L	83 - 87	L4, 8v, OHC	Con buje de 12mm, Aire Acondicionado
			Lebaron K	2.5L	92 - 95	L4, 8v, OHC	Con buje de 12mm, Aire Acondicionado
			Magnum K	5.7L	83 - 88	L4, 8v, OHC	Aire Acondicionado, con buje de 12mm.
			Shadow	2.5L	91 - 94	L4, 8v, OHC	Con buje de 12mm, Aire Acondicionado
			Shadow Turbo	2.2L	90 - 90	L4, 8v, OHC	Con buje de 12mm, Aire Acondicionado
		DODGE	Ram 2500 Van	5.9L	97 - 02	V8, 16v, OHV	Con buje de 12mm.
Ram Charger	5.9L		86 - 89	V8, 16v, OHV	Con buje de 12mm, Aire Acondicionado		
532 0261 20	PGA	CHRYSLER	Concorde	3.5L	95 -97	V6, 24v, OHC	
			Lebaron K	2.5L	92 - 95	L4, 8v, OHC	

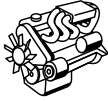
## LISTADO DE APLICACIONES POR No. DE PARTE

	SIGLAS		Lts.				
532 0261 20	PGA	CHRYSLER	New Yorker	2.2L	92 - 94	L4, 8v, OHC	Con buje de 12mm.
			New Yorker	2.5L	92 - 94	L4, 8v, OHC	Con buje de 12mm.
			Shadow	2.2L	89 - 90	L4, 8v, OHC	
			Shadow	2.5L	91 - 94	L4, 8v, OHC	
			Spirit	2.5L	90 - 95	L4, 8v, OHC	Con buje de 12mm.
			Voyager	3.3L	91 - 00	V6, 12v, OHV	
532 0262 20	PGA	FORD	Aerostar	4.0L	94 - 95	V6, 16v, OHV	
			Topaz	2.3L	84 - 94	L4, 8v, OHC	
532 0263 20	PGA	CHEVROLET	Blazer	4.3L	95 - 01	V6, 12v, OHV	
			C 1500 Silverado	4.3L	03 - 06	V6, 12v, OHC	
			Camaro Z28	5.7L	95 - 02	V8, 16v, OHV	
			Impala	3.4L	00 -	V6, 12v, OHV	
			Impala	3.8L	00 - 03	V6, 12v, OHV	
			Malibu	2.4L	97 - 99	L4, 16v, DOHC	
			Malibu	3.1L	97 - 03	V6, 12v, OHV	
			S 10	4.3L	98 - 99	V6, 12v, OHV	
		CHRYSLER	Intrepid	2.7L	1998	V6, 24v, DOHC	
		FORD	Contour	2.0L	96 - 00	L4, 16v, DOHC	
			Contour	2.5L	96 - 00	V6, 24v, DOHC	
			Ghia	3.0L	91 - 94	V6, 12v, OHV	
			Mystique	2.0L	1995	L4, 16v, DOHC	
			Mystique	2.5L	95 - 00	V6, 24v, DOHC	
			Ranger	2.3L	96 - 02	L4, 8v, OHC	
			Ranger	2.5L	98 - 01	L4, 8v, OHC	
			Sable	3.0L	96 - 04	V6, 24v, DOHC	
		LINCOLN	Town Car	4.6L	95 - 06	V8, 16v, OHC	
		PONTIAC	Grand Am	3.4L	94 - 01	V6, 12v, OHV	
			Grand Prix	3.8L	97 - 01	V6, 12v, DOHC	
		VOLKSWAGEN	Pointer	1.8L	98 - 00	L4, 8v, OHV	Aire Acondicionado, Dir. Hidráulica
Pointer	1.8L		00 - 06	L4, 8v, OHC	Aire Acondicionado, Dir. Hidráulica		
Pointer	2.0L		00 - 03	L4, 8v, OHC	Aire Acondicionado, Dir. Hidráulica		
532 0264 20	PGA	CHEVROLET	Lumina	3.8L	95 - 96	V6, 12v, OHV	
		FORD	Ghia	3.0L	91 - 94	V6, 12v, OHV	
		NISSAN	Altima	2.4L	96 - 01	L4, 16v, DOHC	







## LISTADO DE APLICACIONES POR No. DE PARTE



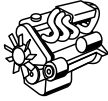

	<b>SIGLAS</b>		<b>Lts.</b>			
--	---------------	--	-------------	--	--	--

532 0265 20	PGA	CADILLAC	Deville	4.6L	95 - 04	V8, 32v, DOHC	
		CHEVROLET	400 Ss	5.7L	93 - 98	V8, 16v, OHV	
			Blazer	4.3L	95 - 01	V6, 12v, OHV	
			C 1500 Silverado	4.3L	03 - 06	V6, 12v, OHC	
			C 1500 Silverado	4.8L	03 - 06	V8, 16v, OHV	
			C 2500 Cheyenne	5.7L	93 - 02	V8, 16v, OHC	
			C 2500 Silverado	5.3L	03 - 06	V8, 16v, OHV	Aire Acondicionado
			C 3500	5.7L	95 - 99	V8, 16v, OHV	
			C 3500 Hd	7.4L	96 - 01	V8, 16v, OHV	Vortec
			Express 3500	4.3L	00 - 03	V6, 12v, OHV	
			Express 3500	5.7L	97 - 02	V8, 16v, OHV	
			Express Van 1500	4.3L	00 - 03	V6, 12v, OHV	
			Express Van 1500	5.7L	97 - 02	V8, 16v, OHV	
			Express Van 2500	4.3L	00 - 03	V6, 12v, OHV	
			Express Van 2500	5.7L	97 - 02	V8, 16v, OHV	
			Impala	3.8L	00 - 03	V6, 12v, OHV	
			Malibu	3.1L	97 - 03	V6, 12v, OHV	
			S 10	4.3L	98 - 99	V6, 12v, OHV	
			Suburban	5.7L	87 - 01	V8, 16v, OHV	
			Tracker Geo	2.0L	97 - 00	L4, 16v, DOHC	
			Uplander	3.5L	05 - 06	V6, 12v, OHV	
		Venture	3.4L	97 - 04	V6, 12v, OHV		
		CHRYSLER	Cirrus	2.5L	96 - 00	L4, 16v, OHC	
			Concorde	3.5L	95 - 02	V6, 24v, OHC	
			Lebaron K	2.5L	92 - 95	L4, 8v, OHC	
			New Yorker	2.5L	92 - 94	L4, 8v, OHC	
		FORD	Cougar	3.8L	85 - 94	V6, 12v, OHV	
			Thunderbird	3.8L	90 - 94	V6, 16v, OHC	
		HONDA	Accord	2.3L	98 - 99	L4, 16v, OHC	VTEC (CE9) / F2272
		JEEP	Wrangler	4.0L	95 - 96	L6, 12v, OHV	
		PONTIAC	Aztek	3.4L	01 - 05	V6, 12v, OHV	

## LISTADO DE APLICACIONES POR No. DE PARTE



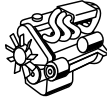

	SIGLAS		Lts.			
532 0266 20	PGA	CHRYSLER	Grand Voyager	3.8L	95 - 00	V6, 12v, OHV
			Town & Country	3.8L	02 -	V6, 12v, OHV
			Voyager	3.3L	91 - 00	V6, 12v, OHV
		DODGE	Caravan	3.3L	2002	V6, 12v, OHV
			Grand Caravan	3.8L	01 - 02	V6, 12v, OHV
		FORD	Contour	2.0L	96 - 00	L4, 16v, DOHC
		JEEP	Liberty	3.7L	02 -	V6, 12v, OHC
532 0267 20	PGA	CHEVROLET	Cavalier	2.2L	95 - 02	L4, 8v, OHV
			Cavalier	2.4L	99 - 01	L4, 16v, DOHC
532 0268 20	PGA	CHEVROLET	Corvette	5.7L	91 - 96	V8, 16v, OHV
		FORD	Cougar	4.9L	91 - 95	V8, 12v, OHC
			Econoline E-150	4.2L	97 - 03	V6, 12v, OHV
			Grand Marquis	4.6L	92 - 04	V8, 16v, OHC
Thunderbird	5.0L	90 - 94	V6, 16v, OHC			
532 0269 20	PGA	CHEVROLET	Blazer	4.3L	95 - 01	V6, 12v, OHV
			C 1500 Silverado	4.3L	03 - 06	V6, 12v, OHC
			C 3500	5.7L	04 - 05	V8, 16v, OHV
			Camaro Z28	5.7L	95 - 02	V8, 16v, OHV
			Express Van 1500	4.3L	00 - 03	V6, 12v, OHV
			S 10	4.3L	98 - 99	V6, 12v, OHV
532 0270 20	PGA	CHEVROLET	Avalanche	5.3L	02 -	V8, 16v, OHV
			C 1500 Silverado	4.8L	03 - 06	V8, 16v, OHV
			C 2500 Silverado	5.3L	03 - 06	V8, 16v, OHV
			Corvette	5.7L	91 - 04	V8, 16v, OHV
			Yukon	5.3L	2007	V8, 16v, OHV
		PONTIAC	Firebird	5.7L	94 - 01	V8, 16v, OHV
532 0271 20	PGA	PONTIAC	Boneville	3.8L	95 - 99	V6, 12v, OHV
532 0272 20	PGA	DODGE	Ram 1500	3.9L	94 - 02	V6, 12v, OHV
		DODGE	Ram 1500 Van	3.9L	95 - 03	V6, 12v, OHV
			Ram 1500 Wagon	3.9L	95 - 03	V6, 12v, OHV
			Ram 2500	5.2L	96 - 02	V8, 16v, OHV
			Ram 2500	5.7L	1994	V8, 16v, (230 HP), OHV
			Ram 2500 Van	5.2L	96 - 02	V8, 16v, OHC

## LISTADO DE APLICACIONES POR No. DE PARTE



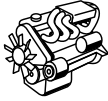

	SIGLAS		Lts.					
532 0272 20	PGA	DODGE	Ram 2500 Wagon	5.2L	95 - 02	V8, 16v, OHV		
			Ram 3500	5.9L	95 - 02	V8, 16v, OHC		
			Ram 3500	5.9L	95 - 02	V8, 16v, OHV		
			Ram 3500 Maxi Wagon	5.2L	95 - 02	V8, 16v, OHV		
			Ram 4000	5.7L	05 - 06	V8, 16v, OHC		
			Ram 4000	5.9L	2002	V8, 16v, OHV		
			Ram Charger	5.2L	99 - 01	V8, 16v, OHV		
			Ram Charger	5.9L	86 - 01	V8, 16v, OHV		
			Ram Van 3500	5.9L	97 - 02	V8, 16v, OHC		
		532 0273 20	PGA	JEEP	Grand Cherokee	3.7L	05 - 06	V6, 12v, OHC
Grand Cherokee	5.2L				95 - 98	V8, 16v, OHV		
Grand Cherokee	5.9L				1998	V8, 16v, OHV		
532 0274 20	PGA	JEEP	Cherokee	4.0L	96 - 01	L6, 12v, OHV	M242	
			Wagoneer	2.5L	91 - 94	L4, 8v, OHV	M150	
			Wrangler	2.5L	95 - 03	L4, 8v, OHV	M150	
			Wrangler	4.0L	91 - 94	L6, 12v, OHV		
532 0275 20	PGA	FORD	Econoline E-150	4.2L	97 - 03	V6, 12v, OHV		
532 0276 20	PGA	FORD	Econoline Wagon	5.4L	99 - 05	V8, 16v, OHC		
			F-250	5.4L	99 - 06	V8, 16v, OHC		
			Taurus	3.8L	98 - 91	V6, 12v, OHC		
			Thunderbird	3.8L	90 - 94	V6, 16v, OHC		
			Blazer	4.3L	1995	V6, 12v, OHV		
532 0276 21	PGA		CHEVROLET	C 20	5.7L	90 - 94	V8, 16v, OHC	
				C 2500 Cheyenne	5.7L	92 - 96	V8, 16v, OHC	
				C 35	5.7L	90 - 94	V8, 16v, OHC	
		C 3500		5.7L	90 - 95	V8, 16v, OHC		
		S 10		4.3L	91 - 95	V6, 16v, OHV		
		S 10		4.3L	94 - 95	V6, 12v, OHV		
		Suburban		5.7L	90 - 95	V8, 16v, OHV		
532 0276 21	PGA	FORD	Mustang Gt	4.6L	96 - 00	V8, 16v, OHC		
532 0276 21	PGA	FORD	Mustang Cobra	4.6L	96 - 00	V8, 16v, OHC		





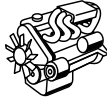

## LISTADO DE APLICACIONES POR No. DE PARTE

	SIGLAS		Lts.				
532 0277 20	PGA	FORD	F-450	6.8L	99 - 05	V10, 20v, OHV	Triton
		FORD	F-450	7.3L	00 - 03	V8, 16v, OHV	
			F-450	7.5L	97 - 98	V8, 16v, OHV	
			F-550	6.8L	03 - 05	V10, 20v, OHV	Triton
532 0278 20	PGA	FORD	Bronco	4.6L	93 - 95	V8, 16v, OHC	
		FORD	Bronco	5.0L	93 - 95	V8, 16v, OHC	
			Bronco	5.4L	93 - 95	V8, 16v, OHC	
			Bronco	5.8L	93 - 95	V8, 16v, OHC	
			F-250	5.0L	92 - 97	V8, 16v, OHC	
			F-250	5.8L	94 - 95	V8, 16v, OHC	Triton
			F-350	5.0L	93 - 95	V8, 16v, OHC	
F-350	5.8L	90 - 95	V8, 16v, OHC				
532 0279 20	PGA	HONDA	Accord	2.3L	98 - 99	L4, 16v, OHC	VTEC (CE9) / F2272
			Civic	1.6L	97 - 00	L4, 16v, OHC	
		PONTIAC	Boneville	3.8L	95 - 99	V6, 12v, OHV	
532 0280 20	PGA	CHEVROLET	P 31	5.7L	85 - 88	V8, 16v, OHV	
		INFINITI	I 30	3.0L	98 - 00	V6, 24v, DOHC	
		NISSAN	Altima	2.4L	96 - 01	L4, 16v, DOHC	
			Frontier	2.4L	01 - 04	L4, 16v, DOHC	
			Frontier	3.3L	01 - 04	V6, 12v, OHC	
			Maxima	3.0L	95 - 99	V6, 24v, DOHC	
			Pick Up	2.4L	94 - 05	L4, 12v, OHC	
			Quest	3.0L	97 - 98	V6, 12v, OHC	
			Quest	3.3L	99 - 02	V6, 12v, OHC	
			Urvan	2.4L	00 - 03	L4, 16v, OHV	
			Urvan	2.4L	03 -	L4, 16v, DOHC	
			X Terra	2.4L	00 - 04	L4, 16v, DOHC	
			X Terra	3.3L	00 - 04	V6, 12v, OHC	
532 0285 20	PGA	CHRYSLER	300m	3.5L	98 - 04	V6, 24v, OHC	Aire Acondicionado
			Concorde	3.2L	2001	V6, 24v, OHC	Aire Acondicionado
			Concorde	3.5L	95 - 02	V6, 24v, OHC	
			Intrepid	3.5L	95 - 97	V6, 24v, OHC	
			Lebaron Lhs	3.5L	96 - 97	V6, 24v, OHC	Aire Acondicionado
			New Yorker Lhs	3.5L	1995	V6, 24v, OHC	Aire Acondicionado
532 0304 10	PGA	CHRYSLER	Pt Cruiser	2.4L	01 -	L4, 16v, DOHC	
		MERCEDES BENZ	Sprinter	2.1L	07 -	L4, 16v, OHC	
532 0308 10	PGD	RENAULT	Clio	2.0L	02 - 06	L4, 16v, DOHC	
			Megane	2.0L	01 -	L4, 16v, DOHC	
			Scenic	2.0L	01 -	L4, 16v, DOHC	



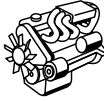

## LISTADO DE APLICACIONES POR No. DE PARTE

	SIGLAS		Lts.				
532 0309 10	PGA	CHEVROLET	Chevy	1.4L	94 - 00	L4, 8v, OHC	Aire Acondicionado
			Chevy	1.6L	96 - 03	L4, 8v, OHC	Aire Acondicionado
532 0312 20	PGD	AUDI	A4	1.8 T	00 - 02	L4, 20v, DOHC	
		SEAT	Leon Turbo	1.8L	01 - 05	L4, 20v, DOHC	
			Toledo Turbo	1.8L	01 - 05	L4, 20v, DOHC	
		VOLKSWAGEN	Golf A4	1.8L	01 - 05	L4, 20v, DOHC	
			Jetta A4	1.8L	00 - 05	L4, 20v, DOHC	
			New Beetle Turbo	1.8L	00 - 05	L4, 20v, DOHC	
		Sharan Turbo	1.8L	02 -	L4, 20v, DOHC		
532 0317 10	PGD	VOLVO	C70 Turbo	2.3L	99 - 01	L5, 20v, DOHC	
			S40 Turbo	2.0L	99 - 04	L5, 20v, DOHC	
			S60 Turbo	2.0L	01 - 04	L5, 20v, DOHC	
			S60 Turbo	2.4L	01 - 03	L5, 20v, DOHC	
			S70 Turbo	2.4L	99 - 00	L5, 20v, DOHC	
			V70 Turbo	2.3L	00 - 03	L5, 20v, DOHC	
532 0320 10	PGA	FORD	Ecosport	2.0L	04 -	L4, 16v, DOHC	
532 0373 20	PGD	ALFA ROMEO	156	2.5L	2002	L4, 16v, DOHC	
532 0446 10	PGD	RENAULT	Clio	2.0L	02 - 06	L4, 16v, DOHC	
			Megane	2.0L	01 -	L4, 16v, DOHC	
			Scenic	2.0L	01 -	L4, 16v, DOHC	
532 0484 10	PGD	FORD	Aerostar	3.0L	91 - 93	V6, 12v, OHC	
			Aerostar	4.0L	94 - 95	V6, 12v, OHV	
			Explorer	4.0L	91 - 94	V6, 12v, OHV	
			Explorer	5.0L	95 - 01	V8, 16v, OHV	
532 0485 10	PGA	CHEVROLET	Silhouette	3.8L	94 - 95	V6, 12v, OHV	
		FORD	Sable	3.0L	96 - 97	V6, 24v, DOHC	
			Windstar	3.8L	95 - 98	V6, 12v, OHV	
		NISSAN	Frontier	3.3L	01 - 04	V6, 12v, OHC	
			X Terra	3.3L	00 - 04	V6, 12v, OHC	
532 0486 10	PGA	FORD	Econoline Van	4.9L	95 - 96	L6, 12v, OHV	
			Econoline Van	5.4L	97 - 03	V8, 16v, OHC	
			Econoline Van	6.8L	97 - 01	V10, 20v, OHC	
			Excursion	6.8L	01 - 05	V10, 20v, OHC	
			Expedition	4.6L	97 - 01	V8, 16v, OHC	
			Expedition	5.4L	97 - 01	V8, 16v, OHC	
			F-150	4.9L	95 - 97	L6, 12v, OHC	
			F-250	4.6L	97 - 01	V8, 16v, OHC	



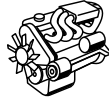

## LISTADO DE APLICACIONES POR No. DE PARTE

	SIGLAS		Lts.				
532 0486 10	PGA	FORD	F-250	4.9L	1995	L6, 12v, OHC	
			F-250	5.4L	99 - 01	V8, 16v, OHC	
			F-350	4.9L	1995	V8, 16v, OHC	
			F-350	5.4L	99 - 01	V8, 16v, OHC	
			F-550	6.8L	03 - 05	V10, 20v, OHV	
		LINCOLN	Navigator	5.4L	98 - 00	V8, 16v, OHC	
532 0487 10	PGA	CADILLAC	Deville	4.6L	95 - 04	V8, 32v, DOHC	Con buje de 10mm.
		CHRYSLER	300m	3.5L	98 - 04	V6, 24v, OHC	Con buje de 10mm.
			Breeze	2.0L	1996	L4, 16v, (150 HP), DOHC	Con buje de 10mm.
			Breeze	2.4L	1996	L4, 16v, (150 HP), DOHC	Con buje de 10mm.
			Cirrus	2.5L	96 - 00	V6, 24v, OHV	
			Cirrus Turbo	2.4L	97 - 01	L4, 16v, DOHC	Con buje de 10mm.
			Concorde	3.2L	2001	V6, 24v, OHC	Con buje de 10mm.
			Concorde	3.5L	95 - 02	V6, 24v, OHC	Con buje de 10mm.
			Dakota	2.5L	1996	L4, 8v, OHC	Con buje de 10mm, Mecanismo autoajustable
			Dakota	3.7L	05 -	V6, 12v, OHV	Con buje de 10mm.
			Dakota	4.7L	2007	V8, 16v, OHV	Con buje de 10mm.
			Durango	4.7L	01 -	V8, 16v, OHC	Con buje de 10mm.
			Grand Voyager	3.8L	95 - 02	V6, 12v, OHV	Con buje de 10mm.
			Lebaron Lhs	3.5L	96 - 97	V6, 24v, OHC	Con buje de 10mm. Alternador, Dir. Hidráulica
			New Yorker Lhs	3.5L	1995	V6, 24v, OHC	Con buje de 10mm.
			Stratus	2.4L	95 - 02	L4, 16v, DOHC	Con buje de 10mm.
			Town & Country	3.8L	95 - 01	V6, 12v, OHV	Con buje de 10mm.
			Voyager	3.3L	00 - 01	V6, 12v, OHV	Con buje de 10mm.
			Voyager	3.3L	95 - 01	V6, 12v, OHV	Con buje de 10mm.
			DODGE	Caravan	3.3L	90 - 00	V6, 12v, OHV
		Caravan		3.8L	96 - 00	V6, 12v, OHV	Con buje de 10mm.
		Grand Caravan		3.3L	90 - 00	V6, 12v, OHV	Con buje de 10mm.
		Grand Caravan		3.8L	94 - 00	V6, 12v, OHV	Con buje de 10mm.
		Ram 1500		3.7L	03 - 06	V6, 12v, OHC	Con buje de 10mm.
		Ram 2500		4.7L	02 - 06	V8, 16v, OHV	Con buje de 10mm.
		JEEP	Cherokee	4.0L	98 - 01	L6, 12v, OHV	Con buje de 10mm.
			Grand Cherokee	4.0L	93 - 99	L6, 12v, OHV	Con buje de 10mm.



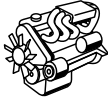

## LISTADO DE APLICACIONES POR No. DE PARTE

	SIGLAS		Lts.				
532 0487 10	PGA	JEEP	Grand Cherokee	4.7L	99 - 05	V8, 16v, OHC	Con buje de 10mm.
			Liberty	3.7L	02 -	V6, 12v, OHC	Con buje de 10mm.
			Wrangler	2.5L	87 - 02	L4, 8v, OHV	Con buje de 10mm.
			Wrangler	4.0L	91 - 99	L6, 12v, OHV	Con buje de 10mm.
532 0488 10	PGA	FORD	F-200	5.0L	85 - 86	V8, 16v, OHV	
			Fairmont	5.0L	78 - 83	V8, 16v, OHV	
			Ltd	5.0L	80 - 81	V8, 16v, OHV	
			Mustang	5.0L	1984	V8, 16v, OHV	
532 0489 10	PGA	MERCEDES BENZ	Clase C 36	3.6L	96 - 97	L6, 24v, DOHC	
			Clase E 320	3.2L	96 - 97	L6, 18v, DOHC	
532 0490 10	PGA	FORD	Cougar	3.8L	85 - 88	V6, 12v, OHC	
			Grand Marquis	3.8L	85 - 86	V6, 12v, OHC	
			Thunderbird	3.8L	85 - 88	V6, 12v, OHC	
532 0491 10	PGA	TOYOTA	4 Runner	4.7L	03 -	V8, 32v, DOHC	
			Land Cruiser	4.7L	05 - 06	V8, 32v, DOHC	
			Tundra	4.7L	2007	V8, 32v, DOHC	
532 0492 10	PGA	HONDA	Accord	3.0L	03 - 06	V6, 24v, OHV	
			Odyssey	3.5L	05 - 06	V6, 24v, OHC	
			Pilot	3.5L	05 - 06	V6, 24v, OHC	
532 0493 10	PGA	CHRYSLER	Dakota	2.5L	1996	L4, 8v, OHC	Con buje de 10mm, Mecanismo fijo
			Town & Country	3.8L	02 -	V6, 12v, OHV	Con buje de 10mm.
			Voyager	3.3L	02 - 04	V6, 12v, OHV	Con buje de 10mm.
	PGA	DODGE	Caravan	3.3L	01 - 03	V6, 12v, OHV	Con buje de 10mm.
			Grand Caravan	3.3L	01 - 03	V6, 12v, OHV	Con buje de 10mm.
			Grand Caravan	3.8L	01 - 04	V6, 12v, OHV	Con buje de 10mm.
	PGA	JEEP	Cherokee	4.0L	98 - 01	L6, 12v, OHV	Con buje de 10mm.
			Grand Cherokee	4.0L	98 - 04	L6, 12v, OHV	Con buje de 10mm, Mecanismo Fijo
			Wrangler	2.5L	87 - 02	L4, 8v, OHV	Con buje de 10mm.
			Wrangler	4.0L	98 - 06	L6, 12v, OHV	Con buje de 10mm.
532 0494 10	PGA	AUDI	A3	2.0L	05 - 06	L4, 16v, DOHC	
			Tt Quattro	1.8 T	99 - 06	L4, 20v, DOHC	
	PGA	BMW	325ci	2.5L	95 - 06	L6, 24v, DOHC	Aire Acondicionado
			325i	2.5L	95 - 06	L6, 24v, (170 - 190 HP), DOHC	Aire Acondicionado

## LISTADO DE APLICACIONES POR No. DE PARTE



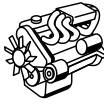

	SIGLAS		Lts.				
532 0494 10	PGA	BMW	325xi	2.5L	95 - 06	L6, 24v, (170 - 190 HP), DOHC	
			330ci	3.0L	01 - 06	L6, 24v, DOHC	Aire Acondicionado
			330i	3.0L	01 - 06	L6, 24v, DOHC	
			330xi	3.0L	01 - 06	L6, 24v, DOHC	Aire Acondicionado
			525i	2.5L	01 - 06	L6, 24v, DOHC	Aire Acondicionado
			530i	3.0L	02 - 06	L6, 24v, (228 HP) DOHC	Aire Acondicionado
			M3	3.2L	96 - 04	L6, 24v, DOHC	Aire Acondicionado
			X3	2.5L	04 -	L6, 24v, DOHC	Aire Acondicionado
			X3	3.0L	04 -	L6, 24v, DOHC	Aire Acondicionado
			X5	3.0L	01 -	L6, 24v, DOHC	Aire Acondicionado
			X5	4.4L	00 - 06	V8, 24v, DOHC	Aire Acondicionado
			Z3	3.2L	00 - 02	L6, 24v, (317, 321 HP), DOHC	Aire Acondicionado
			Z4	2.5L	03 -	L6, 24v, DOHC	Aire Acondicionado
			Z4	3.0L	03 -	L6, 24v, DOHC	Aire Acondicionado
		CHRYSLER	Town & Country	3.8L	02 -	V6, 12v, OHV	
		Voyager	3.3L	02 - 04	V6, 12v, OHV		
		DODGE	Caravan	3.3L	01 - 05	V6, 12v, OHV	
		Grand Caravan	3.3L	01 - 05	V6, 12v, OHV		
		Grand Caravan	3.8L	01 - 05	V6, 12v, OHV		
		FORD	Focus	2.0L	00 - 02	L4, 16v, DOHC	
		Mondeo	2.0L	01 - 04	L4, 16v, DOHC		
		Mystique	2.0L	1995	L4, 16v, DOHC		
		JEEP	Grand Cherokee	4.0L	98 - 04	L6, 12v, OHV	
		Wrangler	2.4L	03 - 06	L4, 8v, OHV		
		Wrangler	4.0L	00 - 06	L6, 12v, OHV		
		TOYOTA	Corolla	1.8L	03 -	L4, 16v, DOHC	
		Matrix	1.8L	03 - 05	L4, 16v, DOHC		
		Mr2 Spyder	1.8L	05 -	L4, 16v, DOHC		
		VOLKSWAGEN	Golf A4	1.8L	00 - 03	L4, 20v, OHC	
		Golf A4	2.0L	00 - 01	L4, 8v, OHC		
		Jetta A4	1.8L	00 - 05	L4, 20v, DOHC		
		Jetta A4	2.0L	99 - 05	L4, 8v, OHC		
		New Beetle	2.0L	98 -	L4, 8v, OHC		
		New Beetle Turbo	1.8L	00 - 05	L4, 20v, DOHC		
		Passat	2.0L	06 -	L4, 16v, DOHC		

## LISTADO DE APLICACIONES POR No. DE PARTE



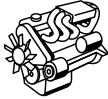

	<b>SIGLAS</b>		<b>Lts.</b>			
--	---------------	---	-------------	---	---	---

532 0495 10	PGA	CHRYSLER	Grand Voyager	3.8L	95 - 02	V6, 12v, OHV	Con buje de 12mm.
			Town & Country	3.8L	95 - 01	V6, 12v, OHV	Con buje de 12mm, Aire Acondicionado
			Voyager	3.3L	95 - 01	V6, 12v, OHV	Con buje de 12mm.
		DODGE	Caravan	3.3L	90 - 00	V6, 12v, OHV	Con buje de 12mm, Aire Acondicionado
			Caravan	3.8L	96 - 00	V6, 12v, OHV	Con buje de 12mm, Aire Acondicionado
			Grand Caravan	3.3L	90 - 00	V6, 12v, OHV	Con buje de 12mm.
			Grand Caravan	3.8L	94 - 00	V6, 12v, OHV	Con buje de 12mm, Aire Acondicionado
532 0496 10	PGA	VOLKSWAGEN	Eurovan	2.5L	01 - 04	L5, 10v, DOHC	
532 0497 10	PGA	NISSAN	Estaquitas	2.4L	91 - 95	L4, 12v, OHC	
			Ichivan	2.4L	1993	L4, 8v, OHC	
			Pick Up	2.4L	90 - 97	L4, 12v, OHC	
532 0498 10	PGA	CHRYSLER	Cirrus Turbo	2.4L	02 - 06	L4, 16v, DOHC	
			Stratus	2.4L	95 - 02	L4, 16v, DOHC	
532 0499 10	PGA	DODGE	Ram Charger	5.9L	90 - 94	V8, 16v, OHV	
532 0600 20	PGA	MERCEDES BENZ	Clase A 160	1.6L	00 - 05	L4, 8v, OHC	
			Clase A 190	1.9L	01 - 05	L4, 8v, OHC	
532 0601 20	PGA	MERCEDES BENZ	Clase A 160	1.6L	00 - 05	L4, 8v, OHC	
			Clase A 190	1.9L	01 - 05	L4, 8v, OHC	
			Clase A 190	1.9L	01 - 05	L4, 8v, OHC	
532 0602 20	PGA	CHEVROLET	Astra	1.8L	00 - 06	L4, 16v, DOHC	
			Astra	2.0L	04 - 06	L4, 8v, OHC	
			Chevy	1.6L	96 - 03	L4, 8v, OHC	
			Zafira	1.8L	02 - 05	L4, 16v, DOHC	
532 0603 20	PGA	AUDI	A3	1.8 T	98 - 01	L4, 20v, DOHC	
		SEAT	Ibiza	2.0L	03 -	L4, 8v, OHC	
		TOYOTA	Corolla	1.8L	03 -	L4, 16v, DOHC	
			Matrix	1.8L	03 - 05	L4, 16v, DOHC	
			Mr2 Spyder	1.8L	05 -	L4, 16v, DOHC	
		VOLKSWAGEN	Golf A4	2.0L	00 -	L4, 8v, OHC	
			Golf A4 Turbo	1.8L	01 - 06	L4, 20v, DOHC	
			Jetta A4	1.8L	00 - 05	L4, 20v, DOHC	
			Jetta A4	2.0L	99 - 05	L4, 8v, OHC	
			New Beetle	2.0L	98 -	L4, 8v, OHC	
			New Beetle Turbo	1.8L	00 - 05	L4, 20v, DOHC	
			Passat	2.0L	91 - 93	L4, 8v, OHC	
		Passat	2.8L	99 - 05	V6, 24v, DOHC		
Passat Turbo	1.8L	99 - 05	L4, 20v, DOHC				

## LISTADO DE APLICACIONES POR No. DE PARTE



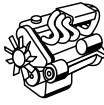

	SIGLAS		Lts.				
533 0001 10	THA	BMW	323i	2.5L	97 - 01	L6, 24v, DOHC	Aire Acondicionado
			325i	2.5L	02 - 04	L6, 24v, (170 - 190 HP), DOHC	Aire Acondicionado
			528i	2.8L	96 - 01	L6, 24v, DOHC	Aire Acondicionado
			Z3	1.9L	96 - 99	L4, 16v, (140 HP), DOHC	Aire Acondicionado
533 0003 10	THA	BMW	328i	2.8L	97 - 98	L6, 24v, DOHC	Alternador / Bomba de agua / Dir. Hidráulica
			330i	3.0L	01 - 04	L6, 24v, DOHC	Alternador / Bomba de agua / Dir. Hidráulica
			M3	3.2L	02 - 03	L6, 24v, DOHC	Alternador / Bomba de agua / Dir. Hidráulica
533 0007 10	THA	BMW	525i	2.5L	01 - 03	L6, 24v, DOHC	
533 0013 10	THA	BMW	540i	4.4L	97 - 00	V8, 32v, DOHC	Alternador / Bomba de agua / Dir. Hidráulica
			740i	4.4L	98 - 00	V8, 32v, DOHC	Alternador / Bomba de agua / Dir. Hidráulica
533 0014 10	THA	BMW	540i	4.4L	97 - 00	V8, 32v, DOHC	Aire Acondicionado
			740i	4.4L	98 - 00	V8, 32v, DOHC	Aire Acondicionado
			M5	3.2L	2006	V10, 24v, DOHC	Aire Acondicionado
533 0015 10	PTA	BMW	323ci	2.5L	97 - 01	L6, 24v, DOHC	
			323i	2.5L	97 - 01	L6, 24v, DOHC	
			323is	2.5L	97 - 01	L6, 24v, DOHC	
			325ci	2.5L	95 - 06	L6, 24v, DOHC	
			325i	2.5L	95 - 06	L6, 24v, (170 - 190 HP), DOHC	
			325is	2.5L	95 - 06	L6, 24v, (170 - 190 HP), DOHC	
			325xi	2.5L	95 - 06	L6, 24v, (170 - 190 HP), DOHC	Aire Acondicionado
			328ci	2.8L	96 - 00	L6, 24v, DOHC	
			328i	2.8L	96 - 00	L6, 24v, DOHC	
			328is	2.8L	96 - 00	L6, 24v, DOHC	
			330ci	3.0L	01 - 06	L6, 24v, DOHC	
			330i	3.0L	01 - 06	L6, 24v, DOHC	
			330xi	3.0L	01 - 06	L6, 24v, DOHC	
			525i	2.5L	01 - 06	L6, 24v, DOHC	
			528i	2.8L	96 - 00	L6, 24v, DOHC	
			530i	3.0L	00 - 06	L6, 24v, (228 HP) DOHC	
			530i	3.0L	95 - 96	L6, 24v, (228 HP) DOHC	

## LISTADO DE APLICACIONES POR No. DE PARTE



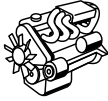

	SIGLAS		Lts.				
533 0015 10	PTA	BMW	M3	3.2L	2001	L6, 24v, DOHC	
			X3	2.5L	04 -	L6, 24v, DOHC	
			X3	3.0L	04 -	L6, 24v, DOHC	
			X5	3.0L	01 -	L6, 24v, DOHC	
			Z3	2.0L	2000	L4, 24v, (150 HP), DOHC	
			Z3	2.8L	97 - 00	L6, 24v, (192 HP), DOHC	
			Z3	3.2L	00 - 02	L6, 24v, (317, 321 HP), DOHC	
			Z4	2.5L	03 -	L6, 24v, DOHC	
			Z4	3.0L	03 -	L6, 24v, DOHC	
533 0017 10	THA	MERCEDES BENZ	Clase C 220	2.2L	95 - 97	L4, 16v, DOHC	
			Sprinter	2.7L	04 - 06	L5, 20v, OHC	Diesel
533 0018 10	THA	MERCEDES BENZ	Clase C 230	2.3L	96 - 03	L4, 16v, DOHC	
			Clase Clk 320	3.2L	98 - 05	V6, 18v, OHC	Cabrio
			Clase E 320	3.2L	96 - 97	L6, 24v, DOHC	
			Clase Slk 230	2.3L	97 - 04	L4, 16v, DOHC	
533 0023 10	PTHA	TOYOTA	Camry	2.4L	02 - 06	L4, 16v, DOHC	
			Rav 4	2.4L	04 -	L4, 16v, DOHC	
533 0030 20	THA	AUDI	A3	1.8 T	98 - 04	L4, 20v, DOHC	
			A3	2.0L	05 - 06	L4, 16v, DOHC	
			S3	1.8L	00 - 04	L4, 20v, DOHC	
			Tt Quattro	1.8 T	99 - 03	L4, 20v, DOHC	
		SEAT	Alhambra Turbo	1.8L	02 -	L4, 20v, DOHC	
			Leon Turbo	1.8L	01 - 05	L4, 20v, DOHC	
			Toledo Turbo	1.8L	01 - 05	L4, 20v, DOHC	
		VOLKSWAGEN	Golf A4 Turbo	1.8L	01 - 06	L4, 20v, DOHC	
			Jetta A4 Turbo	1.8L	00 - 05	L4, 20v, DOHC	
Sharan Turbo	1.8L		02 -	L4, 20v, DOHC			
533 0037 20	THB	VOLKSWAGEN	Passat	2.8L	96 - 97	V6, 12v, DOHC	
533 0072 20	PTA	PEUGEOT	306	1.8L	98 - 02	L4, 16v, OHC	
			306	2.0L	01 - 02	L4, 16v, OHC	
533 0086 30	PTM	VOLKSWAGEN	Eurovan	2.5L	01 - 04	L5, 10v, DOHC	
			Eurovan Diesel	1.9L	06 -	L4, 8v, OHV	
534 0003 10	PTHA	BMW	540i	4.4L	97 - 00	V8, 32v, DOHC	
			740i	4.4L	98 - 00	V8, 32v, DOHC	
			M5	3.2L	2006	V10, 24v, DOHC	





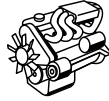

## LISTADO DE APLICACIONES POR No. DE PARTE

	SIGLAS		Lts.				
534 0004 10	PTHA	BMW	540i	4.4L	97 - 00	V8, 32v, DOHC	
			740i	5.4L	98 - 00	V12, 48v, DOHC	
534 0006 10	PTA	MERCEDES BENZ	Clase C 36	3.6L	96 - 97	L6, 24v, DOHC	
			Clase E 320	3.2L	96 - 97	L6, 18v, DOHC	
			Clase SI 320	3.2L	96 - 97	L6, 24v, DOHC	
534 0008 10	PTHA	BMW	323i	2.5L	97 - 01	L6, 24v, DOHC	
			325i	2.5L	95 - 01	L6, 24v, (170 - 190 HP), DOHC	
			328i	2.8L	96 - 00	L6, 24v, DOHC	
			330i	3.0L	01 - 04	L6, 24v, DOHC	
			528i	2.8L	96 - 01	L6, 24v, DOHC	
			M3	3.2L	00 - 03	L6, 24v, DOHC	
534 0009 10	PTHA	BMW	323i	2.5L	97 - 01	L6, 24v, DOHC	
			325i	2.5L	95 - 01	L6, 24v, (170 - 190 HP), DOHC	
			328i	2.8L	96 - 00	L6, 24v, DOHC	
			330i	3.0L	01 - 04	L6, 24v, DOHC	
			528i	2.8L	96 - 01	L6, 24v, DOHC	
			M3	3.2L	00 - 03	L6, 24v, DOHC	
534 0016 10	PTHA	TOYOTA	Corolla	1.8L	03 -	L4, 16v, DOHC	
			Matrix	1.8L	03 - 05	L4, 16v, DOHC	
			Mr2 Spyder	1.8L	05 -	L4, 16v, DOHC	
534 0022 10	PTA	PEUGEOT	307	2.0L	03 -	L4, 16v, DOHC	
			406	2.0L	02 - 05	L4, 16v, DOHC	
534 0036 10	THB	RENAULT	Megane	2.0L	01 -	L4, 16v, DOHC	
534 0037 10	THB	PEUGEOT	206	1.6L	01 -	L4, 16v, DOHC	
534 0123 20	PTA	VOLKSWAGEN	Polo	1.6L	03 -	L4, 8v, OHC	Dir. Hidráulica
534 0124 30	PGD	CHEVROLET	Cavalier	2.2L	95 - 04	L4, 8v, OHV	
			Cavalier	2.3L	1995	L4, 16v, DOHC	
			Hhr	2.4L	06 -	L4, 16v, DOHC	
			Malibu	2.2L	04 - 06	L4, 16v, DOHC	
			Malibu	2.4L	97 - 99	L4, 16v, DOHC	
			Vectra	2.2L	03 - 05	L4, 16v, DOHC	
		Zafira	2.2L	02 - 06	L4, 16v, DOHC		
		PONTIAC	Sunfire	2.2L	02 - 05	L4, 16v, DOHC	
Sunfire	2.4L	97 - 01	L4, 16v, DOHC				
534 0125 30	PTA	FORD	Ikon	1.6L	04 - 06	L4, 8v, OHC	
			Ka	1.6L	04 - 06	L4, 8v, OHC	
534 0126 30	PTA	VOLKSWAGEN	Golf A3 Vr6	2.8L	96 - 99	V6, 12v, DOHC	
			Jetta A3 Vr6	2.8L	93 - 98	V6, 12v, DOHC	
			Passat	2.8L	96 - 97	V6, 12v, DOHC	





## LISTADO DE APLICACIONES POR No. DE PARTE

	SIGLAS		Lts.			
534 0127 30	PTA	AUDI	A4	1.8 T	98 - 06	L4, 20v, DOHC
534 0128 30	PTA	FORD	Ecosport	2.0L	04 -	L4, 16v, DOHC
			Mondeo	2.5L	02 - 04	V6, 24v, DOHC
534 0130 20	PTA	FORD	Focus	2.0L	00 - 03	L4, 16v, DOHC
534 0190 10	PTD	FORD	Escort	2.0L	98 - 01	L4, 16v, DOHC
			Focus	2.0L	00 - 06	L4, 16v, DOHC
534 0191 10	PTA	FORD	Topaz	2.3L	88 - 94	L4, 8v, OHC
534 0193 10	PTA	FORD	Bronco	4.9L	91 - 92	L6, 12v, OHC
			Econoline Van	4.9L	95 - 96	L6, 12v, OHV
			F-150	4.9L	95 - 97	L6, 12v, OHC
534 0194 10	PTA	FORD	Aerostar	4.0L	94 - 95	V6, 12v, OHV
			Explorer	4.0L	91 - 94	V6, 12v, OHV
534 0195 10	PTA	TOYOTA	4 Runner	4.7L	03 -	V8, 32v, DOHC
			Land Cruiser	4.7L	04 - 06	V8, 32v, DOHC
			Tundra	4.7L	2007	V8, 32v, DOHC
534 0196 10	PTA	FORD	Ranger	2.3L	96 - 02	L4, 8v, OHC
			Ranger	2.5L	98 - 01	L4, 8v, OHC
534 0197 10	PTA	CHRYSLER	Dakota	3.7L	05 -	V6, 12v, OHV
			Dakota	4.7L	2007	V8, 16v, OHV
			Durango	4.7L	01 -	V8, 16v, OHC
		DODGE	Ram 1500	3.7L	03 - 06	V6, 12v, OHC
			Ram 2500	4.7L	02 - 06	V8, 16v, OHV
		JEEP	Grand Cherokee	4.7L	99 - 05	V8, 16v, OHC
Liberty	3.7L	02 -	V6, 12v, OHC			
534 0198 10	PTA	FORD	Explorer	4.0L	00 - 06	V6, 12v, OHV
534 0199 10	PTA		Windstar	3.8L	99 - 04	V6, 12v, OHV
534 0200 10	PTA	FORD	Escort	2.0L	98 - 01	L4, 16v, DOHC
			Zx2	2.0L	2003	L4, 16v, DOHC
			Zx3	2.0L	03 - 04	L4, 16v, DOHC
534 0201 10	PTA	FORD	Explorer	5.0L	95 - 01	V8, 16v, OHV
534 0202 10	PTA	CHEVROLET	Cavalier	2.2L	01 - 04	L4, 8v, OHV
		PONTIAC	Sunfire	2.2L	02 - 05	L4, 16v, DOHC
534 0203 10	PTA	CHEVROLET	Luv	2.2L	99 - 05	L4, 8v, OHC
			S 10	2.2L	98 - 03	L4, 8v, OHV
			S 10	4.3L	98 - 99	V6, 16v, OHV
534 0204 10	PTA	CHEVROLET	Tracker	2.0L	99 - 04	L4, 16v, DOHC
534 0205 10	PTA	FORD	Contour	2.0L	96 - 98	L4, 16v, DOHC
			Mystique	2.0L	1995	L4, 16v, DOHC



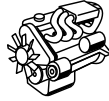

## LISTADO DE APLICACIONES POR No. DE PARTE

	SIGLAS		Lts.				
534 0206 10	PTA	CHEVROLET	Colorado	2.8L	04 - 06	L4, 16v, DOHC	
			Colorado	3.5L	04 - 06	L5, 20v, DOHC	
			Trail Blazer	4.2L	02 -	L6, 24v, DOHC	
		HUMMER	H3	3.5L	2006	L5, 20v, DOHC	
534 0207 10	PTA	FORD	Sable	3.0L	96 - 00	V6, 24v, DOHC	
534 0208 10	PTA	FORD	Mustang	5.0L	94 - 95	V8, 16v, OHV	
534 0209 10	PTA	CHRYSLER	Town & Country	3.8L	02 -	V6, 12v, OHV	
			Voyager	3.3L	02 - 04	V6, 12v, OHV	
		DODGE	Caravan	3.3L	01 - 04	V6, 12v, OHV	
			Grand Caravan	3.3L	01 - 05	V6, 12v, OHV	
			Grand Caravan	3.8L	01 - 04	V6, 12v, OHV	
JEEP	Wrangler	2.4L	03 - 06	L4, 8v, OHV			
534 0210 10	PTA	FORD	Contour	2.0L	98 - 00	L4, 16v, DOHC	
			Mondeo	2.0L	01 - 04	L4, 16v, DOHC	
534 0211 10	PTA	FORD	Grand Marquis	4.6L	00 - 04	V8, 16v, OHC	
			Mustang	4.6L	00 - 04	V8, 16v, OHC	
		LINCOLN	Town Car	4.6L	00 - 05	V8, 16v, OHC	
534 0212 10	PTA	FORD	Econoline Van	4.6L	04 - 06	V8, 16v, OHV	
			Econoline Wagon	5.4L	02 - 06	V8, 16v, OHC	Aire Acondicionado
			Excursion	6.8L	01 - 05	V10, 20v, OHC	
			Expedition	4.6L	02 - 04	V8, 16v, OHC	
			Expedition	5.4L	02 - 06	V8, 16v, OHC	Triton
			Explorer	4.6L	02 - 06	V8, 16v, OHC	
			F-250	4.6L	02 - 06	V8, 16v, OHC	
			F-250	5.4L	02 - 06	V8, 16v, OHC	
			F-350	5.4L	02 - 05	V8, 16v, OHC	
			F-450	6.8L	02 - 04	V10, 20v, OHV	
			F-550	6.8L	03 - 05	V10, 20v, OHV	Aire Acondicionado
		LINCOLN	Aviator	4.6L	03 - 05	V8, 32v, DOHC	
Navigator	5.4L	01 - 05	V8, 32v, DOHC				
534 0213 10	PTA	CHEVROLET	Cavalier	2.4L	2001	L4, 16v, DOHC	
			Malibu	2.4L	97 - 99	L4, 16v, DOHC	
		PONTIAC	Sunfire	2.4L	97 - 01	L4, 16v, DOHC	
534 0214 10	PTA	FORD	Focus	2.0L	00 - 06	L4, 16v, DOHC	
			Freestar	4.2L	00 - 06	L4, 16v, DOHC	
534 0215 10	PTA	HONDA	Accord	2.4L	03 - 06	L4, 16v, DOHC	
			Cr V	2.4L	02 - 06	L4, 16v, DOHC	

## LISTADO DE APLICACIONES POR No. DE PARTE

	SIGLAS		Lts.				
534 0216 10	PTA	NISSAN	Altima	2.5L	02 - 06	L4, 16v, DOHC	
			Sentra	2.5L	02 - 06	L4, 16v, DOHC	
			X Trail	2.5L	02 - 07	L4, 16v, DOHC	
534 0217 10	PTA	CHRYSLER	300	3.5L	06 - 07	V6, 24v, OHV	
			300	5.7L	05 - 07	V8, 16v, OHV	
			Pacifica	3.5L	04 - 06	V6, 24v, OHV	
			Phantom Turbo	2.2L	97 - 89	L4, 8v, OHC	
534 0218 10	PTA	FORD	Econoline Van	5.4L	98 - 01	V8, 16v, OHC	
			Econoline Van	6.8L	97 - 01	V10, 20v, OHC	
			F-250	4.6L	97 - 01	V8, 16v, OHC	
			F-250	5.4L	99 - 01	V8, 16v, OHC	
			F-350	5.4L	99 - 01	V8, 16v, OHC	
			F-450	6.8L	98 - 01	V10, 20v, OHV	
534 0219 10	PTA	HONDA	Accord	3.0L	03 - 06	V6, 24v, OHV	
			Odyssey	3.5L	05 - 06	V6, 24v, OHC	
			Pilot	3.5L	05 - 06	V6, 24v, OHC	
534 0220 10	PTA	FORD	Econoline Van	4.6L	04 - 06	V8, 16v, OHV	
			Econoline Wagon	5.4L	02 - 06	V8, 16v, OHC	Sin Aire Acondicionado
			F-250	4.6L	02 - 06	V8, 16v, OHC	
			F-250	5.4L	02 - 06	V8, 16v, OHC	
			F-350	5.4L	02 - 05	V8, 16v, OHC	
			F-550	6.8L	03 - 05	V10, 20v, OHV	
534 0221 10	PTA	FORD	Cougar	3.8L	89 - 90	V6, 12v, OHV	Versión XR-7
			Thunderbird	3.8L	89 - 94	V6, 12v, OHC	
534 0222 10	PTA	FORD	Cougar	3.8L	85 - 94	V6, 12v, OHV	Versión XR-7
			Thunderbird Sch	3.8L	89 - 94	V6, 12v, OHC	Con buje de 70mm.
534 0223 10	PTA	FORD	Cougar	3.8L	85 - 94	V6, 12v, OHV	Versión XR-7
			Thunderbird Sch	3.8L	89 - 94	V6, 12v, OHC	Con buje de 76mm.
534 0224 10	PTA	NISSAN	Armada	5.6L	04 - 07	V8, 32v, DOHC	
			Titan	5.6L	04 - 07	V8, 32v, DOHC	
534 0225 10	PTA	FORD	Escape	3.0L	2005	V6, 24v, DOHC	
		FORD	Five Hundred	3.0L	05 - 07	V6, 24v, DOHC	
			Mariner	3.0L	05 - 07	V6, 24v, DOHC	
			Thunderbird	3.9L	03 - 04	V8, 32v, DOHC	
		JAGUAR	S Type	4.0L	99 - 02	V8, 32v, DOHC	
			X Type	2.5L	01 - 05	V6, 24v, DOHC	

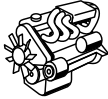
## LISTADO DE APLICACIONES POR No. DE PARTE

	SIGLAS		Lts.				
534 0225 10	PTA	JAGUAR	X Type	3.0L	01 - 05	V6, 24v, DOHC	
			Xk Type	4.0L	98 - 02	V8, 32v, DOHC	
	LINCOLN	LS	3.0L	04 - 05	V6, 24v, DOHC		
		LS	3.9L	00 - 06	V8, 32v, DOHC		
534 0226 10	PTA	CADILLAC	Escalade	5.3L	02 - 05	V8, 16v, OHV	Aire Acondicionado
			Escalade	6.0L	02 - 05	V8, 16v, OHV	
	CHEVROLET	Avalanche	5.3L	02 - 07	V8, 16v, OHV	Aire Acondicionado	
		C 1500 Silverado	4.8L	03 - 06	V8, 16v, OHV	Aire Acondicionado	
		C 2500 Silverado	5.3L	03 - 06	V8, 16v, OHV		
		Express	5.3L	03 - 07	V8, 16v, OHV	Aire Acondicionado	
		Express	6.0L	03 - 07	V8, 16v, OHV	Aire Acondicionado	
		Sierra	5.3L	07 - 07	V8, 16v, OHV	Aire Acondicionado	
		Sonora	5.3L	03 - 06	V8, 16v, OHV		
		Suburban	5.3L	03 - 07	V8, 16v, OHV	Aire Acondicionado	
		Tahoe	5.3L	07 - 07	V8, 16v, OHV	Aire Acondicionado	
		Trail Blazer	5.3L	02 - 07	V8, 32v, DOHC		
	Yukon	5.3L	07 - 07	V8, 16v, OHV			
	HUMMER	H2	6.0L	05 - 07	V8, 16v, OHV	Aire Acondicionado	
534 0227 10	PTA	CHEVROLET	Camaro Z28	5.7L	95 - 02	V8, 16v, OHV	Aire Acondicionado
			Corvette	5.7L	95 - 04	V8, 16v, OHV	Aire Acondicionado
		PONTIAC	Firebird	5.7L	94 - 99	V8, 16v, OHV	Aire Acondicionado
534 0228 10	PTA	CADILLAC	Deville	4.6L	95 - 04	V8, 32v, DOHC	
			Eldorado	4.6L	93 - 97	V8, 32v, DOHC	
			Seville	4.6L	95 - 04	V8, 32v, DOHC	
534 0229 10	PTA	CHEVROLET	Corvette	5.7L	95 - 04	V8, 16v, OHV	
534 0230 10	PTA	FORD	Escape	3.0L	01 - 04	V6, 24v, DOHC	
			Sable	3.0L	01 - 05	V6, 24v, DOHC	
534 0231 10	PTA	CHEVROLET	Camaro Z28	5.7L	95 - 02	V8, 16v, OHV	
		PONTIAC	Firebird	5.7L	94 - 99	V8, 16v, OHV	
534 0232 10	PTA	CHEVROLET	Impala	3.8L	00 - 03	V6, 12v, OHV	
534 0233 10	PTA	HONDA	Accord	3.0L	03 - 06	V6, 24v, OHV	Aire Acondicionado
			Odyssey	3.5L	2000	V6, 24v, OHC	Aire Acondicionado
534 0234 10	PTA	HONDA	Odyssey	3.5L	01 - 04	V6, 24v, OHC	Aire Acondicionado
			Pilot	3.5L	03 - 04	V6, 24v, OHC	Aire Acondicionado
534 0235 10	PTA	HONDA	Odyssey	3.5L	01 - 04	V6, 24v, OHC	Con Amortiguador Hidráulico, Aire Acondicionado
534 0236 10	PTA	CADILLAC	Escalade	5.3L	02 - 05	V8, 16v, OHV	
		CADILLAC	Escalade	6.0L	02 - 05	V8, 16v, OHV	
		CHEVROLET	Avalanche	5.3L	02 - 07	V8, 16v, OHV	

## LISTADO DE APLICACIONES POR No. DE PARTE

	SIGLAS		Lts.				
534 0236 10	PTA	CHEVROLET	C 1500 Silverado	4.8L	03 - 06	V8, 16v, OHV	
			C 2500 Silverado	5.3L	03 - 06	V8, 16v, OHV	Alternador / Bomba de agua / Dir. Hidráulica
			Express	5.3L	03 - 07	V8, 16v, OHV	
			Express	6.0L	03 - 07	V8, 16v, OHV	
			Sierra	5.3L	07 - 07	V8, 16v, OHV	Alternador / Bomba de agua / Dir. Hidráulica
			Sonora	5.3L	03 - 06	V8, 16v, OHV	Alternador / Bomba de agua / Dir. Hidráulica
			Suburban	5.3L	03 - 07	V8, 16v, OHV	
			Tahoe	5.3L	07 - 07	V8, 16v, OHV	
			Trail Blazer	5.3L	02 - 07	V8, 32v, DOHC	Alternador / Bomba de agua / Dir. Hidráulica
			Yukon	5.3L	07 - 07	V8, 16v, OHV	Alternador / Bomba de agua / Dir. Hidráulica
	HUMMER	H2	6.0L	05 - 07	V8, 16v, OHV		
534 0237 10	PTA	CADILLAC	Deville	4.6L	95 - 04	V8, 32v, DOHC	
			Eldorado	4.6L	95 - 97	V8, 32v, DOHC	
			Seville	4.6L	95 - 04	V8, 32v, DOHC	
534 0238 10	PTA	FORD	Escape	3.0L	01 - 04	V6, 24v, DOHC	
535 0001 10	PGL	VOLKSWAGEN	New Beetle	2.0L	98 -	L4, 8v, OHC	Alternador BOSCH 70A/90A
			Passat	2.0L	91 - 93	L4, 8v, OHC	Alternador BOSCH 70A/90A
535 0012 10	PGL	AUDI	Tt Quattro	1.8 T	99 - 06	L4, 20v, DOHC	Alternador BOSCH 70A/90A
			SEAT	Alhambra Turbo	1.8L	02 -	L4, 20v, DOHC
		Leon		1.8L	01 - 05	L4, 20v, DOHC	Alternador BOSCH 70A/90A
		Toledo		1.8L	01 - 05	L4, 20v, DOHC	Alternador BOSCH 70A/90A
		VOLKSWAGEN	Golf A4	1.8L	00 - 01	L4, 8v, OHC	Alternador BOSCH 70A/90A
			Golf A4	2.0L	00 - 03	L4, 8v, OHC	
			Jetta A4	1.8L	00 - 06	L4, 20v, DOHC	Alternador BOSCH 70A/90A
Jetta A4	2.0L	99 - 06	L4, 8v, OHC	Alternador			
535 0012 10	PGL	VOLKSWAGEN	New Beetle	2.0L	98 -	L4, 8v, OHC	Alternador BOSCH 70A/90A
			New Beetle Turbo	1.8L	00 - 05	L4, 20v, DOHC	Alternador BOSCH 70A/90A
			Sharan Turbo	1.8L	02 -	L4, 20v, DOHC	Alternador BOSCH 70A/90A
535 0025 10	PGL	PORSCHE	911	3.4L	99 - 02	L6, 24v, DOHC	Alternador
			Boxter	2.7L	01 - 04	L6, 24v, DOHC	Alternador
			Boxter	3.2L	01 - 04	L6, 24v, DOHC	Alternador
			Boxter	3.2L	01 - 04	L6, 24v, DOHC	Alternador
		MERCEDES BENZ	Clase A 160	1.6L	00 - 05	L4, 8v, OHC	Alternador
535 0045 10	PGL	MERCEDES BENZ	Clase A 160	1.6L	00 - 05	L4, 8v, OHC	Alternador

## SECCIÓN DE IMÁGENES

**531 0003 10**



Aplicaciones en pág.: **52**

**531 0004 10**



Aplicaciones en pág.: **52**

**531 0018 10**

**No Ilustrado**

Aplicaciones en pág.: **52**

**531 0019 10**



Aplicaciones en pág.: **52**

**531 0020 10**



Aplicaciones en pág.: **52**

**531 0021 10**



Aplicaciones en pág.: **52**

**531 0030 10**



Aplicaciones en pág.: **52**

**531 0047 10**



Aplicaciones en pág.: **52**

**531 0054 30**



Aplicaciones en pág.: **52**

**531 0063 10**



Aplicaciones en pág.: **52**

**531 0063 11**



Aplicaciones en pág.: **52**

**531 0079 10**



Aplicaciones en pág.: **52**

## SECCIÓN DE IMÁGENES

**531 0083 10**



Aplicaciones en pág.: **52**

**531 0090 10**



Aplicaciones en pág.: **53**

**531 0095 10**



Aplicaciones en pág.: **53**

**531 0096 10**



Aplicaciones en pág.: **53**

**531 0101 30**



Aplicaciones en pág.: **53**

**531 0118 20**



Aplicaciones en pág.: **53**

**531 0121 20**



Aplicaciones en pág.: **53**

**531 0123 20**



Aplicaciones en pág.: **53**

**531 0131 20**



Aplicaciones en pág.: **53**

**531 0132 20**



Aplicaciones en pág.: **53**

**531 0177 20**



Aplicaciones en pág.: **53**

**531 0181 20**



Aplicaciones en pág.: **53**



## SECCIÓN DE IMÁGENES

**531 0193 20**



Aplicaciones en pág.: **53**

**531 0203 20**



Aplicaciones en pág.: **53**

**531 0208 20**



Aplicaciones en pág.: **53**

**531 0214 20**



Aplicaciones en pág.: **53**

**531 0241 10**



Aplicaciones en pág.: **53**

**531 0251 30**



Aplicaciones en pág.: **53**

**531 0252 30**



Aplicaciones en pág.: **53**

**531 0258 10**



Aplicaciones en pág.: **54**

**531 0265 10**



Aplicaciones en pág.: **54**

**531 0267 10**



Aplicaciones en pág.: **54**

**531 0273 30**



Aplicaciones en pág.: **54**

**531 0276 30**



Aplicaciones en pág.: **54**

## SECCIÓN DE IMÁGENES

**531 0278 30**



Aplicaciones en pág.: **54**

**531 0280 10**



Aplicaciones en pág.: **54**

**531 0286 30**



Aplicaciones en pág.: **54**

**531 0288 30**



Aplicaciones en pág.: **54**

**531 0292 30**



Aplicaciones en pág.: **54**

**531 0298 30**



Aplicaciones en pág.: **54**

**531 0306 10**



Aplicaciones en pág.: **54**

**531 0309 10**



Aplicaciones en pág.: **54**

**531 0312 10**



Aplicaciones en pág.: **54**

**531 0314 20**



Aplicaciones en pág.: **54**

**531 0317 10**



Aplicaciones en pág.: **54**

**531 0322 10**



Aplicaciones en pág.: **54**

## SECCIÓN DE IMÁGENES

**531 0326 10**



Aplicaciones en pág.: **55**

**531 0333 20**



Aplicaciones en pág.: **55**

**531 0334 10**



Aplicaciones en pág.: **55**

**531 0339 10**



Aplicaciones en pág.: **55**

**531 0345 10**



Aplicaciones en pág.: **55**

**531 0346 10**



Aplicaciones en pág.: **55**

**531 0353 10**



Aplicaciones en pág.: **55**

**531 0364 10**



Aplicaciones en pág.: **55**

**531 0368 10**



Aplicaciones en pág.: **55**

**531 0370 10**



Aplicaciones en pág.: **55**

**531 0371 10**



Aplicaciones en pág.: **55**

**531 0380 10**



Aplicaciones en pág.: **56**

## SECCIÓN DE IMÁGENES

**531 0409 30**



Aplicaciones en pág.: **56**

**531 0410 30**



Aplicaciones en pág.: **56**

**531 0427 10**



Aplicaciones en pág.: **56**

**531 0429 20**



Aplicaciones en pág.: **56**

**531 0430 10**



Aplicaciones en pág.: **56**

**531 0430 20**



Aplicaciones en pág.: **56**

**531 0431 30**



Aplicaciones en pág.: **56**

**531 0433 20**



Aplicaciones en pág.: **57**

**531 0434 30**



Aplicaciones en pág.: **57**

**531 0435 30**



Aplicaciones en pág.: **57**

**531 0436 20**



Aplicaciones en pág.: **57**

**531 0437 30**



Aplicaciones en pág.: **57**

## SECCIÓN DE IMÁGENES

**531 0438 30**



Aplicaciones en pág.: **57**

**531 0439 20**



Aplicaciones en pág.: **57**

**531 0440 20**



Aplicaciones en pág.: **57**

**531 0440 30**



Aplicaciones en pág.: **57**

**531 0441 20**



Aplicaciones en pág.: **57**

**531 0442 30**



Aplicaciones en pág.: **57**

**531 0443 30**



Aplicaciones en pág.: **57**

**531 0444 30**



Aplicaciones en pág.: **57**

**531 0445 20**



Aplicaciones en pág.: **57**

**531 0446 10**



Aplicaciones en pág.: **57**

**531 0446 20**



Aplicaciones en pág.: **57**

**531 0447 20**



Aplicaciones en pág.: **57**

## SECCIÓN DE IMÁGENES

**531 0448 20**



Aplicaciones en pág.: **58**

**531 0449 20**



Aplicaciones en pág.: **58**

**531 0450 20**



Aplicaciones en pág.: **58**

**531 0451 20**



Aplicaciones en pág.: **58**

**531 0452 20**



Aplicaciones en pág.: **58**

**531 0453 20**



Aplicaciones en pág.: **58**

**531 0454 20**



Aplicaciones en pág.: **58**

**531 0455 20**



Aplicaciones en pág.: **58**

**531 0456 20**



Aplicaciones en pág.: **58, 59**

**531 0457 20**



Aplicaciones en pág.: **59**

**531 0459 20**



Aplicaciones en pág.: **59**

**531 0460 20**



Aplicaciones en pág.: **59**

## SECCIÓN DE IMÁGENES

**531 0461 20**



Aplicaciones en pág.: **59**

**531 0462 20**



Aplicaciones en pág.: **59**

**531 0463 20**



Aplicaciones en pág.: **59**

**531 0478 10**



Aplicaciones en pág.: **59**

**531 0479 10**



Aplicaciones en pág.: **59**

**531 0487 30**



Aplicaciones en pág.: **59, 60**

**531 0488 30**



Aplicaciones en pág.: **60**

**531 0490 30**



Aplicaciones en pág.: **60**

**531 0500 20**



Aplicaciones en pág.: **60**

**531 0518 30**



Aplicaciones en pág.: **60**

**531 0521 30**



Aplicaciones en pág.: **61**

**531 0531 20**



Aplicaciones en pág.: **61**

## SECCIÓN DE IMÁGENES

**531 0537 30**



Aplicaciones en pág.: **61**

**531 0541 10**



Aplicaciones en pág.: **61**

**531 0546 10**



Aplicaciones en pág.: **61**

**531 0560 00**



Aplicaciones en pág.: **61**

**531 0563 00**



Aplicaciones en pág.: **61**

**531 0566 40**



Aplicaciones en pág.: **61**

**531 0567 00**



Aplicaciones en pág.: **61**

**531 0568 00**



Aplicaciones en pág.: **61**

**531 0585 20**



Aplicaciones en pág.: **61**

**531 0586 10**



Aplicaciones en pág.: **61**

**531 0647 20**



Aplicaciones en pág.: **61**

**531 0793 10**



Aplicaciones en pág.: **61**



## SECCIÓN DE IMÁGENES

**531 0794 10**



Aplicaciones en pág.: **62**

**531 0795 10**



Aplicaciones en pág.: **62**

**531 0796 10**



Aplicaciones en pág.: **62**

**531 0797 10**



Aplicaciones en pág.: **62**

**531 0798 10**



Aplicaciones en pág.: **63**

**531 0799 10**



Aplicaciones en pág.: **63**

**531 0800 10**



Aplicaciones en pág.: **63**

**531 1133 71**



Aplicaciones en pág.: **63**

**531 2201 10**



Aplicaciones en pág.: **63**

**532 0001 10**



Aplicaciones en pág.: **63**

**532 0016 10**



Aplicaciones en pág.: **63**

**532 0020 10**



Aplicaciones en pág.: **63**

## SECCIÓN DE IMÁGENES

**532 0028 10**



Aplicaciones en pág.: **63**

**532 0030 10**



Aplicaciones en pág.: **63**

**532 0031 10**



Aplicaciones en pág.: **63**

**532 0033 10**



Aplicaciones en pág.: **63**

**532 0034 10**



Aplicaciones en pág.: **63**

**532 0039 10**



Aplicaciones en pág.: **63**

**532 0040 10**



Aplicaciones en pág.: **63**

**532 0051 10**



Aplicaciones en pág.: **63**

**532 0059 10**



Aplicaciones en pág.: **63**

**532 0066 10**



Aplicaciones en pág.: **64**

**532 0067 10**



Aplicaciones en pág.: **64**

**532 0074 20**



Aplicaciones en pág.: **64**

## SECCIÓN DE IMÁGENES

**532 0087 10**



Aplicaciones en pág.: **64**

**532 0092 20**



Aplicaciones en pág.: **64**

**532 0093 10**



Aplicaciones en pág.: **64**

**532 0109 10**



Aplicaciones en pág.: **64**

**532 0111 10**



Aplicaciones en pág.: **64**

**532 0120 10**



Aplicaciones en pág.: **64**

**532 0123 10**



Aplicaciones en pág.: **64**

**532 0124 10**



Aplicaciones en pág.: **64**

**532 0132 20**

**No Ilustrado**

Aplicaciones en pág.: **64**

**532 0138 10**



Aplicaciones en pág.: **65**

**532 0139 10**



Aplicaciones en pág.: **65**

**532 0142 10**



Aplicaciones en pág.: **65**

## SECCIÓN DE IMÁGENES

**532 0143 10**



Aplicaciones en pág.: **65**

**532 0150 10**



Aplicaciones en pág.: **65**

**532 0151 10**



Aplicaciones en pág.: **65**

**532 0152 10**



Aplicaciones en pág.: **65**

**532 0159 10**



Aplicaciones en pág.: **65**

**532 0160 10**



Aplicaciones en pág.: **65**

**532 0161 10**



Aplicaciones en pág.: **65**

**532 0162 10**



Aplicaciones en pág.: **65**

**532 0167 10**



Aplicaciones en pág.: **65**

**532 0169 10**



Aplicaciones en pág.: **65**

**532 0180 20**



Aplicaciones en pág.: **65**

**532 0185 10**



Aplicaciones en pág.: **65**

## SECCIÓN DE IMÁGENES

**532 0187 10**



Aplicaciones en pág.: **65**

**532 0209 10**

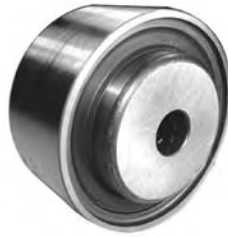

Aplicaciones en pág.: **65**

**532 0221 10**



Aplicaciones en pág.: **65**

**532 0227 10**



Aplicaciones en pág.: **66**

**532 0229 10**



Aplicaciones en pág.: **66**

**532 0233 10**



Aplicaciones en pág.: **66**

**532 0234 10**



Aplicaciones en pág.: **66**

**532 0242 10**



Aplicaciones en pág.: **66**

**532 0243 10**



Aplicaciones en pág.: **66**

**532 0254 10**



Aplicaciones en pág.: **66**

**532 0261 10**



Aplicaciones en pág.: **66**

**532 0261 20**



Aplicaciones en pág.: **66, 67**

## SECCIÓN DE IMÁGENES

**532 0262 20**



Aplicaciones en pág.: **67**

**532 0263 20**



Aplicaciones en pág.: **67**

**532 0264 20**



Aplicaciones en pág.: **67**

**532 0265 20**



Aplicaciones en pág.: **68**

**532 0266 20**



Aplicaciones en pág.: **69**

**532 0267 20**



Aplicaciones en pág.: **69**

**532 0268 20**



Aplicaciones en pág.: **69**

**532 0269 20**



Aplicaciones en pág.: **69**

**532 0270 20**



Aplicaciones en pág.: **69**

**532 0271 20**



Aplicaciones en pág.: **69**

**532 0272 20**



Aplicaciones en pág.: **69, 70**

**532 0273 20**



Aplicaciones en pág.: **70**

## SECCIÓN DE IMÁGENES

**532 0274 20**



Aplicaciones en pág.: **70**

**532 0275 20**



Aplicaciones en pág.: **70**

**532 0276 20**



Aplicaciones en pág.: **70**

**532 0276 21**

**No Ilustrado**

Aplicaciones en pág.: **70**

**532 0277 20**



Aplicaciones en pág.: **71**

**532 0278 20**



Aplicaciones en pág.: **71**

**532 0279 20**



Aplicaciones en pág.: **71**

**532 0280 20**



Aplicaciones en pág.: **71**

**532 0285 20**



Aplicaciones en pág.: **71**

**532 0304 10**



Aplicaciones en pág.: **71**

**532 0308 10**



Aplicaciones en pág.: **71**

**532 0309 10**



Aplicaciones en pág.: **72**

## SECCIÓN DE IMÁGENES

**532 0312 20**



Aplicaciones en pág.: **72**

**532 0317 10**



Aplicaciones en pág.: **72**

**532 0320 10**



Aplicaciones en pág.: **72**

**532 0373 20**



Aplicaciones en pág.: **72**

**532 0446 10**



Aplicaciones en pág.: **72**

**532 0484 10**

**No Ilustrado**

Aplicaciones en pág.: **72**

**532 0485 10**

**No Ilustrado**

Aplicaciones en pág.: **72**

**532 0486 10**



Aplicaciones en pág.: **72, 73**

**532 0487 10**



Aplicaciones en pág.: **73, 74**

**532 0488 10**



Aplicaciones en pág.: **74**

**532 0489 10**



Aplicaciones en pág.: **74**

**532 0490 10**



Aplicaciones en pág.: **74**



## SECCIÓN DE IMÁGENES

**532 0491 10**



Aplicaciones en pág.: **74**

**532 0492 10**



Aplicaciones en pág.: **74**

**532 0493 10**



Aplicaciones en pág.: **74**

**532 0494 10**

**No Ilustrado**

Aplicaciones en pág.: **74, 75**

**532 0495 10**



Aplicaciones en pág.: **76**

**532 0496 10**

**No Ilustrado**

Aplicaciones en pág.: **76**

**532 0497 10**



Aplicaciones en pág.: **76**

**532 0498 10**

**No Ilustrado**

Aplicaciones en pág.: **76**

**532 0499 10**



Aplicaciones en pág.: **76**

**532 0600 20**



Aplicaciones en pág.: **76**

**532 0601 20**



Aplicaciones en pág.: **76**

**532 0602 20**



Aplicaciones en pág.: **76**

## SECCIÓN DE IMÁGENES

**532 0603 20**



Aplicaciones en pág.: **76**

**533 0001 10**



Aplicaciones en pág.: **77**

**533 0003 10**



Aplicaciones en pág.: **77**

**533 0007 10**



Aplicaciones en pág.: **77**

**533 0013 10**



Aplicaciones en pág.: **77**

**533 0014 10**



Aplicaciones en pág.: **77**

**533 0015 10**



Aplicaciones en pág.: **77, 78**

**533 0017 10**



Aplicaciones en pág.: **78**

**533 0018 10**



Aplicaciones en pág.: **78**

**533 0023 10**



Aplicaciones en pág.: **78**

**533 0030 20**



Aplicaciones en pág.: **78**

**533 0037 20**



Aplicaciones en pág.: **78**

## SECCIÓN DE IMÁGENES

**533 0072 20**



Aplicaciones en pág.: **78**

**533 0086 30**



Aplicaciones en pág.: **78**

**534 0003 10**



Aplicaciones en pág.: **78**

**534 0004 10**



Aplicaciones en pág.: **79**

**534 0006 10**



Aplicaciones en pág.: **79**

**534 0008 10**



Aplicaciones en pág.: **79**

**534 0009 10**



Aplicaciones en pág.: **79**

**534 0016 10**



Aplicaciones en pág.: **79**

**534 0022 10**



Aplicaciones en pág.: **79**

**534 0036 10**



Aplicaciones en pág.: **79**

**534 0037 10**



Aplicaciones en pág.: **79**

**534 0123 20**



Aplicaciones en pág.: **79**

## SECCIÓN DE IMÁGENES

**534 0124 30**



Aplicaciones en pág.: **79**

**534 0125 30**

No Ilustrado

Aplicaciones en pág.: **79**

**534 0126 30**



Aplicaciones en pág.: **79**

**534 0127 30**



Aplicaciones en pág.: **80**

**534 0128 30**



Aplicaciones en pág.: **80**

**534 0130 20**



Aplicaciones en pág.: **80**

**534 0190 10**



Aplicaciones en pág.: **80**

**534 0191 10**



Aplicaciones en pág.: **80**

**534 0193 10**



Aplicaciones en pág.: **80**

**534 0194 10**



Aplicaciones en pág.: **80**

**534 0195 10**



Aplicaciones en pág.: **80**

**534 0196 10**



Aplicaciones en pág.: **80**

## SECCIÓN DE IMÁGENES

**534 0197 10**



Aplicaciones en pág.: **80**

**534 0198 10**



Aplicaciones en pág.: **80**

**534 0199 10**



Aplicaciones en pág.: **80**

**534 0200 10**



Aplicaciones en pág.: **80**

**534 0201 10**



Aplicaciones en pág.: **80**

**534 0202 10**



Aplicaciones en pág.: **80**

**534 0203 10**



Aplicaciones en pág.: **80**

**534 0204 10**



Aplicaciones en pág.: **80**

**534 0205 10**



Aplicaciones en pág.: **80**

**534 0206 10**



Aplicaciones en pág.: **81**

**534 0207 10**



Aplicaciones en pág.: **81**

**534 0208 10**



Aplicaciones en pág.: **81**

## SECCIÓN DE IMÁGENES

**534 0209 10**



Aplicaciones en pág.: **81**

**534 0210 10**



Aplicaciones en pág.: **81**

**534 0211 10**



Aplicaciones en pág.: **81**

**534 0212 10**



Aplicaciones en pág.: **81**

**534 0213 10**



Aplicaciones en pág.: **81**

**534 0214 10**



Aplicaciones en pág.: **81**

**534 0215 10**



Aplicaciones en pág.: **81**

**534 0216 10**



Aplicaciones en pág.: **82**

**534 0217 10**



Aplicaciones en pág.: **82**

**534 0218 10**



Aplicaciones en pág.: **82**

**534 0219 10**



Aplicaciones en pág.: **82**

**534 0220 10**



Aplicaciones en pág.: **82**

## SECCIÓN DE IMÁGENES

**534 0221 10**



Aplicaciones en pág.: **82**

**534 0222 10**



Aplicaciones en pág.: **82**

**534 0223 10**



Aplicaciones en pág.: **82**

**534 0224 10**



Aplicaciones en pág.: **82**

**534 0225 10**

**No Ilustrado**

Aplicaciones en pág.: **82, 83**

**534 0226 10**



Aplicaciones en pág.: **83**

**534 0227 10**



Aplicaciones en pág.: **83**

**534 0228 10**



Aplicaciones en pág.: **83**

**534 0229 10**



Aplicaciones en pág.: **83**

**534 0230 10**



Aplicaciones en pág.: **83**

**534 0231 10**



Aplicaciones en pág.: **83**

**534 0232 10**



Aplicaciones en pág.: **83**

## SECCIÓN DE IMÁGENES

**534 0233 10**



Aplicaciones en pág.: **83**

**534 0234 10**



Aplicaciones en pág.: **83**

**534 0235 10**



Aplicaciones en pág.: **83**

**534 0236 10**



Aplicaciones en pág.: **83, 84**

**534 0237 10**



Aplicaciones en pág.: **84**

**534 0238 10**



Aplicaciones en pág.: **84**

**535 0001 10**



Aplicaciones en pág.: **84**

**535 0012 10**



Aplicaciones en pág.: **84**

**535 0025 10**



Aplicaciones en pág.: **84**

**535 0045 10**



Aplicaciones en pág.: **84**



## INTERCAMBIOS

No. E.O.	No. AS	SIGLAS	NUMERO INA	ATECH / TENDECO / LITENS	DAYCO
----------	--------	--------	------------	--------------------------	-------

### ALFA ROMEO

6060 356	532 0373 20	PGD			
6060 7965	532 0120 10	PGD			
6065 2129	532 0120 10	PGD			
6066 4403	532 0120 10	PGD			
6067 1573	532 0120 10	PGD			
6081 2624	532 0120 10	PGD			
6081 3311	532 0373 20	PGD			
6081 3415	532 0120 10	PGD			

### AUDI

11287515867	532 0494 10	PGA		900125	
028903028E	535 0012 10	PGL		930003	
028903029G	535 0012 10	PGL		930003	
037903025C	535 0012 10	PGL		930003	
038903018B	535 0012 10	PGL		930003	
038903023S	535 0012 10	PGL		930003	
058.109.243 B	531 0333 20	PTD	F-123808		
058.109.244	532 0161 10	PGD	F-225531/F-227242		
058.903.133D	531 0292 30	PTA	F-550492	950442	
06A903315D	531 0288 30	PTA	F-235782	950414	
06A903315E	531 0288 30	PTA	F-235782	950414	
06B.109.243	531 0500 20	PTD	F-125067		
06B.109.243B	531 0531 20	PTD	F-125066		
06B.109.243D	531 0500 20	PTD	F-125067		
06B.109.244	532 0312 20	PGD			
06B.109.477	533 0030 20	THA	F-125068		
06B109477	532 0603 20	PGA	F-125068	900036	
06B903133	534 0127 30	PTA		999074	
077 109 244 D	531 0380 10	PTD	F-234848		
077 109 244 E	531 0380 10	PTD	F-234848		
077 903 341	532 0066 10	PGA		900142	89075
078 903 133AB	531 0490 30	PTA		950440	89336
078109244H	532 0159 10	PGD			

### BMW

11281427252	533 0015 10	PTA	F-230206	999141	89342
11281433571	531 0346 10	PTA	F-230207	999058	
11281709613	533 0013 10	THA	F-231285-100	999072	
11281715630	531 0004 10	PTA	F-220695.1	900071	
11281717188	531 0003 10	PTA	F-220090.1	900003	89413
11281717387	534 0008 10	PTHA	F-231289		



## INTERCAMBIOS

No. E.O.	No. AS	SIGLAS	NUMERO INA	ATECH / TENDECO / LITENS	DAYCO
----------	--------	--------	------------	--------------------------	-------

### BMW

11281720039	531 0004 10	PTA	F-220695.1	900071	
11281726181	531 0003 10	PTA	F-220090.1	900003	89413
11281730571	531 0003 10	PTA	F-220090.1	900003	89413
11281742859	531 0267 10	PTA	F-231286.03		
11281742859	531 0267 10	PTA	F-231286.03		
11281745545	533 0014 10	THA	F-231286-100	999073	
11281745547	534 0003 10	PTHA	F-231286		
11281748130	531 0003 10	PTA	F-220090.1	900003	89413
11281748131	532 0001 10	PGA	F-220259.2	900136	
11282243510	533 0007 10	THA	F-227252-100		
11282243592	532 0059 10	PGA	F-123780		
11282244754	532 0059 10	PGA	F-123780		
11282245087	531 0095 10	PGA		900004	89088
11287515867	532 0494 10	PGA		900125	
64552245584	531 0322 10	PTA	F-231107		
112871717210	533 0001 10	THA	F-221646-100	999063	

### CADILLAC

3520623	531 0445 20	PTA		999046	89223
3521853	531 0445 20	PTA		999046	89223
3539155	534 0237 10	PTA		999417	89317
3539606	531 0445 20	PTA		999046	89223
3543027	531 0445 20	PTA		999046	89223
4792112	532 0487 10	PGA		900055	89097
9202550	531 0560 00	PTA		950236	89286
12554027	534 0236 10	PTA		999033	89253
12562347	534 0228 10	PTA		999156	89266
12565372	534 0226 10	PTA		999034	89258
24507524	531 0794 10	PGD		900053	89018
90528760	531 0560 00	PTA		950236	89286
XR3E 12A216 BA	532 0265 20	PGA		900022	89007
XR3Z 8678 BA	532 0265 20	PGA		900022	89007

### CHRYSLER/DODGE

3979131	532 0499 10	PGA		900161	89056
4273241	531 0326 10	PTD	F-200017.3		
4315705	531 0364 10	PTD	F-210240.4		
4483221	532 0495 10	PGA		900058	89028
4663515	531 0370 10	PTD	FC 67992.2		
4663534	532 0285 20	PGA	AIRE ACOND	900049	89034
4777394	532 0227 10	PGD	FC 68768.3		

# INTERCAMBIOS

No. E.O.	No. AS	SIGLAS	NUMERO INA	ATECH / TENDECO / LITENS	DAYCO
----------	--------	--------	------------	--------------------------	-------

## CHRYSLER/DODGE

4792112	532 0487 10	PGA		900055	89097
53009508	531 0430 10	PGA		900045	89006
53010161	531 0430 20	PTA		999116	89213
53030958	534 0197 10	PTA		999007	89254
04781570AB	531 0566 40	PTD		978587	
04792495AB	531 2201 10	PTHA	F-236298		
04792495AC	531 2201 10	PTHA	F-236298		
04884320AA	531 0566 40	PTD		978587	
23357-3200	531 0123 20	PTD	F-124078		
24410-02510	531 0585 20	PTD			
24410-22000	531 0118 20	PTD			
4612894AE	531 0429 20	PTA		999103	89251
4668509AB	531 0568 00	PTA		999524	89319
4668509AC	531 0568 00	PTA		999524	89319
4792581AA	532 0493 10	PGA		900056	
4861277AB	534 0209 10	PTA		999047	89280
4861660AA	534 0217 10	PTA		999600	
5010371AA	531 0567 00	PTD		979001	
5096525AA	531 0487 30	PTA		950113	89335
53010158AB	531 0430 20	PTA		999116	89213
	532 0265 20	PGA		900022	89007
	532 0265 20	PGA		900022	89007
	531 0793 10	PGA		900028	89008
	532 0261 10	PGA		900051	89035
	532 0261 20	PGA		900051	89035
	532 0263 20	PGA		999003	89181
	532 0266 20	PGA			89033
	532 0272 20	PGA		900029	
	532 0304 10	PGA	F-238472		
	532 0494 10	PGA		900125	
	532 0498 10	PGA		900514	
4483221	532 0495 10	PGA		900058	89028
4792112	532 0487 10	PGA		900055	89097
4792581AA	532 0493 10	PGA		900056	
4861277AB	534 0209 10	PTA		999047	89280
	532 0266 20	PGA			89033
	532 0494 10	PGA		900125	

## FIAT

46400054	532 0209 10	PGD	F-110628.3		
----------	-------------	-----	------------	--	--



## INTERCAMBIOS

No. E.O.	No. AS	SIGLAS	NUMERO INA	ATECH / TENDECO / LITENS	DAYCO
----------	--------	--------	------------	--------------------------	-------

### FIAT

46416489	531 0280 10	PTD	F-233127.1		
97055254	532 0229 10	PGA	F-110627.4		APV1032

### FORD

1004549	534 0125 30	PTA		999262	
1127103	534 0128 30	PTA	F-125047		
1142000	532 0320 10	PGA			
1152359	532 0320 10	PGA			
1222856	532 0320 10	PGA			
24576073	532 0268 20	PGA			
25527750	532 0274 20	PGA			89001
96183113	532 0276 20	PGA		900006	89014
1F1Z 6B209 AA	534 0230 10	PTA		999003	89281
1L2E 19A216 AB	532 0486 10	PGA		900007	89048
1L2Z 6B209 AA	534 0212 10	PTA		999544	
1S7Q6A228AC	534 0128 30	PTA	F-125047		
2F1Z 6B209 AA	531 0461 20	PTA		999310	89233
	531 0461 20	PTA		999310	89233
	532 0485 10	PGA		900025	89010
2L3Z 6B209 AA	531 0443 30	PTA		999358	
2L3Z 6B209 CA	534 0220 10	PTA		999604	
2S611 9A21 6BA	532 0320 10	PGA			
2S611 9A21 6BB	532 0320 10	PGA			
2S611 9A21 6CA	532 0320 10	PGA			
3W7E 6B209 AA	534 0211 10	PTA		999052	89291
4L8Z 6B209 AA	534 0225 10	PTA		999707	
81SM-6K256-A	531 0019 10	PTD	F-140054		
84SM-6K254-CA	531 0020 10	PTD	F-140055		
	531 0431 30	PTA		999082	
	532 0254 10	PGA	F-236653		
928M-6M250-BC	532 0016 10	PGD	F-140222		
928M-6M250-DC	532 0093 10	PGD	F-140223		
93BB6A228AE	534 0130 20	PTA	F-125056	999051	89318
95FB19A216AA	532 0254 10	PGA	F-236653		
96MF6A228AC	531 0541 10	PTA	F-125054		
96MF6A228AD	531 0541 10	PTA	F-125054		
9787M6M250BB	532 0152 10	PGD	F-231338		
978M-6K254-AC	531 0021 10	PTD	F-140221		
978M-6K254-AD	531 0021 10	PTD	F-140221		
978M-6M250-AA	532 0151 10	PGD	F-231137		

## INTERCAMBIOS

No. E.O.	No. AS	SIGLAS	NUMERO INA	ATECH / TENDECO / LITENS	DAYCO
----------	--------	--------	------------	--------------------------	-------

FORD					
988M-6K254-AC	531 0345 10	PTD	F-140931	979341	
98MM6K254AB	531 0586 10	PTD	F-550126		
98MM6K254AC	531 0586 10	PTD	F-550126		
98MM6K254AD	531 0586 10	PTD	F-550126		
98MM6K254AE	531 0586 10	PTD	F-550126		
98MM6K254BB	531 0586 10	PTD	F-550126		
98MM6K254BC	531 0586 10	PTD	F-550126		
98MM6K254BD	531 0586 10	PTD	F-550126		
E2TZ-6B264A	531 0433 20	PTA		999118	89224
E3SZ8678A	531 0434 30	PTA		999100	89247
E43Z6B217A	532 0262 20	PGA		900035	89002
E7TZ6B209DF5RZ6C348B	532 0265 20	PGA		900022	89007
E83E-6B209-AA	534 0191 10	PTA		999057	89208
E8DZ6B209A	531 0459 20	PTA		999022	89217
E8TA-6B209-AA	531 0433 20	PTA		999118	89224
E7TA-6B209 H	534 0193 10	PTA		999006	89222
	531 0433 20	PTA		999118	89224
	534 0193 10	PTA		999006	89222
E90E 6B209 A	534 0190 10	PTD		979002	89010
E90E 6B209 BA	534 0190 10	PTD		979002	89010
E9SZ8678A	531 0434 30	PTA		999100	89247
F02Z 6C348A	534 0190 10	PTD		979002	89010
F02Z68209A	532 0262 20	PGA		900035	89002
F0CZ6C348A	531 0435 30	PTA		999077	89248
F13Z-6B209-A	534 0191 10	PTA		999057	89208
	531 0795 10	PGA		900020	89037
	532 0484 10	PGD		900024	89026
F23Z66B209B	532 0263 20	PGA		999003	89181
F23Z8676A	532 0263 20	PGA		999003	89181
F2SE-19A216-AA	531 0794 10	PGD		900053	89018
F2SZ6C348A	531 0438 30	PTA		999001	89221
F2TZ 6B209 A	534 0196 10	PTA		999031	89261
F3AE6B209AA	531 0460 20	PTA		979455	89218
F3DE6B209 AB	531 0461 20	PTA		999310	89233
F3TA6B209EB	531 0462 20	PTA			89236
F3TZ6B209AA	531 0441 20	PTA		999009	89230
F4CZ6B209A	531 0435 30	PTA		999077	89248
F4DZ 6C348 C	532 0485 10	PGA		900025	89010
F4DZ6C348C	532 0264 20	PGA		900025	89010



## INTERCAMBIOS

No. E.O.	No. AS	SIGLAS	NUMERO INA	ATECH / TENDECO / LITENS	DAYCO
----------	--------	--------	------------	--------------------------	-------

FORD					
F4SZ 6B209 A	534 0221 10	PTA		999086	
F4SZ 6B209 C	534 0223 10	PTA		999104	
F4SZ 6B209 D	534 0222 10	PTA		999087	
F4ZZ 6B209 A	534 0208 10	PTA		999044	89296
F57E6K254AA	531 0368 10	PTD	FC 65251.2		
F5RZ 8W508 A	534 0238 10	PTA		999238	
F5RZ6M250A	532 0016 10	PGD	F-140222		
F5RZ6M250B	532 0093 10	PGD	F-140223		
F65E-19A216-AA	532 0486 10	PGA		900007	89048
F65E6B209AC	531 0463 20	PTA			
F65Z 6B209 BA	534 0201 10	PTA		999036	89306
F65Z 8678 AAA	532 0486 10	PGA		900007	89048
	531 0437 30	PTA		999266	89237
F6AZ878BA	532 0263 20	PGA		999003	89181
F6DZ 6B209 DA	534 0207 10	PTA		999056	89295
F75Z 6B209 EA	534 0218 10	PTA		999267	
F7CZ6K254AA	531 0442 30	PTA		999324	
F7RZ 6A228 AA	534 0205 10	PTA		999035	89307
F87Z 6B209 CA	534 0196 10	PTA		999031	89261
F8AZ 6B209 AA	531 0460 20	PTA		999005	89218
F8CZ 6B209 AA	534 0200 10	PTA		999037	89308
F8CZ6M250AA	532 0151 10	PGD	F-231137		
F8RZ 8678 AA	532 0494 10	PGA		900125	
IL3Z6B209AA	531 0444 30	PTA		999187	
J3240577	532 0278 20	PGA			89020
XF2Z 6B209 AA	534 0199 10	PTA		999029	89262
XR3Z 6B209 AB	534 0211 10	PTA		999052	89291
XS4Z6M250BA	532 0152 10	PGD	F-231338		
XS6E6K255AA	531 4468 07	PTA	F-446808-700		
XS7G6M250AA	532 0187 10	PGA	F-233879		
XS7G6M250BA	532 0187 10	PGA	F-233879		
XW4Z 6B209 AA	534 0225 10	PTA		999707	
YC3Z88678AB	531 0438 30	PTA		999001	89221
YF1Z 6B209 AA	532 0485 10	PGA		900025	89010
YL2Z 6B209 AA	534 0198 10	PTA		999021	89252
YS4Z 6B209 AA	534 0214 10	PTA		999497	
YS4Z 8678 AB	532 0494 10	PGA		900125	
YW7Z 8678 AA	531 0799 10	PGA		900162	89051
YZ4Z 6A228 AA	534 0210 10	PTA		999051	89318

## INTERCAMBIOS

No. E.O.	No. AS	SIGLAS	NUMERO INA	ATECH / TENDECO / LITENS	DAYCO
----------	--------	--------	------------	--------------------------	-------

### FORD

ZZL112500	534 0194 10	PTA		999018	89238
	531 0463 20	PTA			
	531 0797 10	PGD		900105	89053
	532 0266 20	PGA			89033
	532 0275 20	PGA			89013
	532 0277 20	PGA		900005	89016
	532 0488 10	PGA		900060	89025
	532 0490 10	PGA		900067	89031

### CHEVROLET

140541	531 0298 30	PTA	F-235783	950242	
636415	532 0039 10	PGD	F-224964		
636416	532 0040 10	PGD	F-224966		
1007000	531 0447 20	PTA		999002	89225
1340534	531 0298 30	PTA	F-235783	950242	
1340542	531 0298 30	PTA	F-235783	950242	
1340555	532 0033 10	PGD	F-224971.01	950205	
1,75E+6	534 0204 10	PTA		999032	89267
5636423	532 0087 10	PGD	F-231413		
5636721	531 0101 30	PTD	F-232482	979111	
5636722	531 0101 30	PTD	F-232482	979111	
6004123	531 0447 20	PTA		999002	89225
9117695	531 0101 30	PTD	F-232482	979111	
9128738	532 0039 10	PGD	F-224964		
9128739	532 0033 10	PGD	F-224971.01		
9128739	532 0033 10	PGD	F-224971.01	950205	
9128740	532 0034 10	PGD	F-224967		
9158003	531 0273 30	PTD	F-234394	979311	
9158004	531 0054 30	PTD	F-232488	979195	
9202478	531 0101 30	PTD	F-232482	979111	
9202550	531 0560 00	PTA		950236	89286
9240033	532 0180 20	PGD	F-124054		
10105371	531 0450 20	PTA		999013	89213
10115478	531 0449 20	PTA		999027	89232
10141997	531 0800 10	PTA		999049	89310
10187658	531 0447 20	PTA		999002	89225
10233134	531 0447 20	PTA		999002	89225
	531 0451 20	PTA		999010	89231
10239670	532 0269 20	PGA		900031	89015
10239930	532 0269 20	PGA		900031	89015



## INTERCAMBIOS

No. E.O.	No. AS	SIGLAS	NUMERO INA	ATECH / TENDECO / LITENS	DAYCO
----------	--------	--------	------------	--------------------------	-------

CHEVROLET					
12554027	534 0236 10	PTA		999033	89253
12559325	534 0229 10	PTA		999588	89337
12560344	534 0231 10	PTA		999360	89338
12560345	534 0227 10	PTA		999361	89339
12563083	531 0452 20	PTA		999553	89241
12563084	531 0456 20	PTA		999101	89203
12564508	534 0232 10	PTA		999558	
12565372	534 0226 10	PTA		999034	89258
12573024	534 0206 10	PTA		999551	89269
14102108	531 0447 20	PTA		999002	89225
24426500	531 0518 30	PTD	F-232481.1	979455	
24430296	534 0124 30	PGD		900033	
24504575	531 0453 20	PTA		999133	89249
24507524	531 0794 10	PGD		900053	89018
24574840	534 0124 30	PGD		900033	
24575252	531 0454 20	PTA		999015	89229
	531 0795 10	PGA		900020	89037
24575354	534 0213 10	PTA		999333	89290
24576073	534 0203 10	PTA		999039	89265
53009508	531 0430 10	PGA		900045	89006
90324097	532 0309 10	PGA	F-220277		
90353176	531 0101 30	PTD	F-232482	979111	
90409238	532 0109 10	PGA	F-224134		
90411773	532 0040 10	PGD	F-224966		
90499101	531 0101 30	PTD	F-232482	979111	
90502129	531 0298 30	PTA	F-235783	950242	
90528760	531 0560 00	PTA		950236	89286
90529810	532 0087 10	PGD	F-231413		
91176512	531 0796 10	PGD		900032	
93297256	531 1133 71	PGA	F-113371		
96459042	531 0298 30	PTA	F-235783	950242	
1754077EA1	534 0204 10	PTA		999032	89267
24 4302 96	531 0521 30	PTA		999581	89316
24 5748 43	534 0202 10	PTA		999038	89264
	531 0446 10	PTA		999012	89227
	531 0446 20	PTA		999019	89228
	531 0448 20	PTA			89211
	531 0798 10	PGD		900159	89052
	532 0263 20	PGA		999003	89181



## INTERCAMBIOS

No. E.O.	No. AS	SIGLAS	NUMERO INA	ATECH / TENDECO / LITENS	DAYCO
----------	--------	--------	------------	--------------------------	-------

### CHEVROLET

	532 0264 20	PGA			89010
	532 0265 20	PGA		900022	89007
	532 0265 20	PGA		900022	89007
	532 0265 20	PGA		900022	89007
	532 0267 20	PGA			89003
	532 0270 20	PGA		900027	89009
	532 0280 20	PGA		900047	89036
	532 0485 10	PGA		900025	89010
	532 0602 20	PGA			

### HONDA

13404-PCA-003	531 0132 20	PTD			
13404-PTO-003	531 0132 20	PTD			
13404-PTO-004	531 0132 20	PTD			
14510-P08-003	531 0314 20	PTD	F-123635		
14510-P08-004	531 0314 20	PTD	F-123635		
14510-P8A-A01	531 0647 20	PTD			
14510-PTO-002	531 0131 20	PTD	F-123816		
14510-PTO-003	531 0131 20	PTD	F-123816		
14510-PTO-004	531 0131 20	PTD	F-123816		
31170P8FA01	534 0233 10	PTA		999505	305256
31170P8FA02	534 0235 10	PTA		999091	
31170PGKA01	534 0234 10	PTA		999537	
31170RAAA02	534 0215 10	PTA		999661	
31170RCAA01	534 0219 10	PTA		999671	
31170RCAA02	532 0492 10	PGA		900114	
38942-P01-003	532 0279 20	PGA		900043	89029
38942-P3F-003	532 0279 20	PGA		900043	89029
38950-P2K-305	532 0279 20	PGA		900043	89029
EGT802733RVN	531 0132 20	PTD			
	532 0265 20	PGA		900022	89007

### HUMMER

12554027	534 0236 10	PTA		999033	89253
12565372	534 0226 10	PTA		999034	89258
12573024	534 0206 10	PTA		999551	89269
	531 0798 10	PGD		900159	89052

### INFINITI

11925-01M00	532 0280 20	PGA		900047	89036
11945-3S510	532 0280 20	PGA		900047	89036
13070-42L00	531 0214 20	PTD			



## INTERCAMBIOS

No. E.O.	No. AS	SIGLAS	NUMERO INA	ATECH / TENDECO / LITENS	DAYCO
----------	--------	--------	------------	--------------------------	-------

### JAGUAR

XR83 6B209 AB	534 0225 10	PTA		999707	
---------------	-------------	-----	--	--------	--

### JEEP

4792112	532 0487 10	PGA		900055	89097
14103118	532 0273 20	PGA			89012
53009508	531 0430 10	PGA		900045	89006
53010161	531 0430 20	PTA		999116	89213
53030958	534 0197 10	PTA		999007	89254
04781570AB	531 0566 40	PTD		978587	
04884320AA	531 0566 40	PTD		978587	
4 8540 89 AB	531 0457 20	PTA		999462	89245
4792581AA	532 0493 10	PGA		900056	
4861277AB	534 0209 10	PTA		999047	89280
53010158AB	531 0430 20	PTA		999116	89213
53010230L	532 0493 10	PGA		900056	
	531 0793 10	PGA		900028	89008
	532 0265 20	PGA		900022	89007
	532 0265 20	PGA		900022	89007
	532 0266 20	PGA			89033
	532 0272 20	PGA		900029	
	532 0494 10	PGA		900125	

### LINCOLN

1L2E 19A216 AB	532 0486 10	PGA		900007	89048
1L2Z 6B209 AA	534 0212 10	PTA		999544	
E2TZ-6B264A	531 0433 20	PTA		999118	89224
E8TA-6B209-AA	531 0433 20	PTA		999118	89224
E8TZ-6B209-A	531 0433 20	PTA		999118	89224
F23Z66B209B	532 0263 20	PGA		999003	89181
F23Z8676A	532 0263 20	PGA		999003	89181
F6AZ878BA	532 0263 20	PGA		999003	89181
F8AZ 6B209 AA	531 0460 20	PTA		999005	89218
XW4Z 6B209 AA	534 0225 10	PTA		999707	
YW7Z 8678 AA	531 0799 10	PGA		900162	89051

### MERCEDES BENZ

2020019	532 0160 10	PGA	F-231069	900149	
2020319	532 0233 10	PGA	F-234843		
1032000870	534 0006 10	PTA		999061	89344
1042000870	531 0488 30	PTA		950104	
1112000770	531 0563 00	PTA		950106	89354
1112000770	533 0018 10	THA	F-231072		

## INTERCAMBIOS

No. E.O.	No. AS	SIGLAS	NUMERO INA	ATECH / TENDECO / LITENS	DAYCO
----------	--------	--------	------------	--------------------------	-------

### MERCEDES BENZ

1112001270	533 0018 10	THA	F-231072		
1122000870	531 0487 30	PTA		950113	89335
1192000370	532 0031 10	PGA	F-220278	900140	
1192000470	532 0030 10	PGA	F-220279		
1202000470	532 0028 10	PGA	F-220280	900139	
1372020119	532 0234 10	PGA	F-234842		
1662020819	532 0600 20	PGA			
6681550615	535 0045 10	PGL	F-232030.5		
2600166A	535 0045 10	PGL	F-232030.5		
5080246AA	532 0160 10	PGA	F-231069	900149	
A1032000570	532 0489 10	PGA		900064	89043
A6112000270	533 0017 10	THA	F-231071		
A6112000370	533 0017 10	THA	F-231071		
A6112000470	533 0017 10	THA	F-231071		
A6112000570	533 0017 10	THA	F-231071		
	531 0018 10	PTA			

### MITSUBISHI

MD115976	531 0121 20	PGD			
MD121993	532 0074 20	PGD			
MD156604	532 0074 20	PGD			
MD182537	531 0193 20	PTD			
MD192731	532 0074 20	PGD			

### NISSAN

7700102931	532 0243 10	PGA	F-124059		
7700107150	532 0221 10	PGD	F-123778		
7700143092	532 0243 10	PGA	F-124059		
11925-00QAB	531 0427 10	PTA	F-123190		
11925-01M00	532 0280 20	PGA		900047	89036
119453S510	532 0280 20	PGA		900047	89036
119454S100	532 0485 10	PGA		900025	89010
1194586G00	532 0497 10	PGA		900046	89039
119557S000	534 0224 10	PTA		999710	
119558J000	534 0216 10	PTA		999601	
13070-01M00	531 0208 20	PTD	F-124065		
13070-01M00	531 0208 20	PTD	F-124065		
13070-V5001	531 0214 20	PTD			



## INTERCAMBIOS

No. E.O.	No. AS	SIGLAS	NUMERO INA	ATECH / TENDECO / LITENS	DAYCO
----------	--------	--------	------------	--------------------------	-------

### NISSAN

	531 0409 30	PTD	F-550223	979420 / 900023	
	531 0427 10	PTA	F-123190		
	531 0427 10	PTA	F-123190		
	531 0427 10	PTA	F-123190		
	532 0264 20	PGA			89010

### PEUGEOT

829,660	531 0546 10	PTD	F-125081		
829,670	531 0546 10	PTD	F-125081		
829,760	531 0546 10	PTD	F-125081		
829,820	531 0478 10	PTD	F-232829.5		
829,930	531 0546 10	PTD	F-125081		
829,970	531 0546 10	PTD	F-125081		
5751,350	533 0072 20	PTA	F-123746		
83042	532 0289 10	PGD	F-124276.1		
575118	531 0096 10	PTA	F-121338.5		
575129	532 0138 10	PGA	F-123749		
575132	531 0258 10	PTA	F-122965		
575134	532 0124 10	PGA	F-123761		
575152	534 0037 10	THB	F-123792		
575160	531 0479 10	PGD	F-125051		
575161	534 0022 10	PTA	F-125050		
96088591	531 0096 10	PTA	F-121338.5		
96201309	532 0020 10	PGD	F-122124		
96218349	534 0037 10	THB	F-123792		
96222692	531 0353 10	PTA	F-122649		
96222715	531 0306 10	PTA	F-122748.11		
96225744	531 0047 10	PTD	F-122868		
96256218	532 0123 10	PGA	F-122966		
96281179	531 0030 10	PTD	F-121287.5		
96287841	531 0241 10	PTD	F-122598		
96338025	531 0265 10	PTA	F-123449		
96362074	534 0022 10	PTA	F-125050		
96366405	531 0479 10	PGD	F-125051		
96374926	531 0478 10	PTD	F-232829.5		
9608989980	532 0138 10	PGA	F-123749		
9632722180	532 0289 10	PGD	F-124276.1		
6453S5	531 0241 10	PTD	F-122598		
0830.20	532 0142 10	PGD	F-122574		
	532 0139 10	PGA	F-123760		

## INTERCAMBIOS

No. E.O.	No. AS	SIGLAS	NUMERO INA	ATECH / TENDECO / LITENS	DAYCO
----------	--------	--------	------------	--------------------------	-------

### PONTIAC

10115478	531 0449 20	PTA		999027	89232
12560344	534 0231 10	PTA		999360	89338
12560345	534 0227 10	PTA		999361	89339
12563083	531 0452 20	PTA		999553	89241
24504575	531 0453 20	PTA		999133	89249
24507524	531 0794 10	PGD		900053	89018
24573503	531 0455 20	PTA		900002	89234
24575354	534 0213 10	PTA		999333	89290
24 5748 40	534 0124 30	PGD		900033	
24 5748 43	534 0202 10	PTA		999038	89264
E8TZ-8678-C	532 0270 20	PGA		900027	89009
F23Z66B209B	532 0263 20	PGA		999003	89181
F23Z8676A	532 0263 20	PGA		999003	89181
F6AZ878BA	532 0263 20	PGA		999003	89181
XR3E 12A216 BA	532 0265 20	PGA		900022	89007
XR3Z 8678 BA	532 0265 20	PGA		900022	89007
	531 0795 10	PGA		900020	89037
	532 0271 20	PGA			
	532 0279 20	PGA		900043	89029

### PORSCHE

99660315250	535 0025 10	PGL		930004	
-------------	-------------	-----	--	--------	--

### RENAULT

7700102931	532 0243 10	PGA	F-124059		
7700105325	531 0427 10	PTA	F-123190		
7700107150	532 0221 10	PGD	F-123778		
7700108117	531 0409 30	PTD	F-550228	979420 / 900023	
7700108626	532 0308 10	PGD	F-123781		
7700114860	531 0410 30	PTD	F-237804	979597	
7700143092	532 0243 10	PGA	F-124059		
7700867985	532 0143 10	PGA	F-122530.12		
8200064664	532 0446 10	PGD	F-239960		
8200192843	531 0427 10	PTA	F-123190		
7700 862 152	534 0036 10	THB	F-123797		
7700870 937	532 0143 10	PGA	F-122530.12		
8200 065 479	532 0143 10	PGA	F-122530.12		
8200 421 284	531 0427 10	PTA	F-123190		
	531 0427 10	PTA	F-123190		



## INTERCAMBIOS

No. E.O.	No. AS	SIGLAS	NUMERO INA	ATECH / TENDECO / LITENS	DAYCO
----------	--------	--------	------------	--------------------------	-------

SEAT					
11287515866	532 0603 20	PGA		900036	
11287515867	532 0603 20	PGA		900036	
028903028E	535 0012 10	PGL			
028903029G	535 0012 10	PGL			
030.109.243D	531 0252 30	PTD	F-232489	979272	
030.109.243F	531 0252 30	PTD	F-232489	979272	
030.109.243J	531 0252 30	PTD	F-232489	979272	
030.109.243K	531 0252 30	PTD	F-232489	979272	
037903025C	535 0012 10	PGL			
038903018B	535 0012 10	PGL			
038903023S	535 0012 10	PGL			
058.109.244	532 0161 10	PGD	F-225531/F-227242		
06A109479A	531 0203 20	PTD	F-123814		
06A903315D	531 0288 30	PTA	F-235782	950414	
06A903315E	531 0288 30	PTA	F-235782	950414	
06B.109.243	531 0500 20	PTD	F-125067		
06B.109.243D	531 0500 20	PTD	F-125067		
06B.109.244	532 0312 20	PGD			
06B.109.477	533 0030 20	THA	F-125068		

TOYOTA					
94856785	534 0016 10	PTHA	F-226239.9	999085	89356
1660450030	532 0491 10	PGA		900678	
1662022011	534 0016 10	PTHA	F-226239.9	999085	89356
1662028011	533 0023 10	PTHA		999060	89360
06B109477	532 0603 20	PGA	F-125068	900036	
13503-62010	532 0092 20	PGD			
13503-62020	532 0092 20	PGD			
13503-62021	532 0092 20	PGD			
13503-62030	532 0092 20	PGD			
13503-62030	532 0092 20	PGD			
13503-62031	532 0092 20	PGD			
13503-62050	532 0092 20	PGD			
13503-62060	532 0092 20	PGD			
13505-02030	531 0181 20	PTD			
13505-15050	531 0181 20	PTD			
13505-15060	531 0181 20	PTD			
13505-20010	531 0177 20	PTD			
13505-20020	531 0177 20	PTD			
13505-20020	532 0092 20	PGD			

## INTERCAMBIOS

No. E.O.	No. AS	SIGLAS	NUMERO INA	ATECH / TENDECO / LITENS	DAYCO
----------	--------	--------	------------	--------------------------	-------

### TOYOTA

13505-62010	532 0092 20	PGD			
13505-62020	531 0177 20	PTD			
13505-62031	531 0177 20	PTD			
13505-62050	531 0177 20	PTD			
13505-62060	531 0177 20	PTD			
166040F010	532 0491 10	PGA		900678	
166200W036	534 0195 10	PTA		999436	89255
	532 0494 10	PGA		900125	

### VOLKSWAGEN

40097001	531 0439 20	PTA		999313	
11287515866	532 0603 20	PGA		900036	
11287515867	532 0603 20	PGA		900036	
021.145.299B	534 0126 30	PTA	F-550493	950400	
021.145.299C	534 0126 30	PTA	F-550493	950400	
026.109.243A	531 0063 10	PTD	F-220093.1		
026.109.243C	531 0063 10	PTD	F-220093.1		
026.109.243E	531 0063 10	PTD	F-220093.1		
026.109.243I	531 0063 11	PTD	F-217668.2C		
027.109.243ABF	531 0083 10	PTD	F-220083.01		
028.109.243B	532 0067 10	PGA	F-214797.4	900075	
028.109.243F	531 0251 30	PTD	F.232486	979286	
028.145.278E	532 0067 10	PGA	F-214797.4	900075	
028.903.119AA	535 0001 10	PGL	F-225355.7		
028.903.119AP	535 0001 10	PGL	F-225355.7		
028.903.315 N	533 0086 30	PTA		950405	
028.903.315 R	533 0086 30	PTA		950405	
028903028E	535 0012 10	PGL		930003	
028903029G	535 0012 10	PGL		930003	
030.109.243D	531 0252 30	PTD	F-232489	979272	
030.109.243F	531 0252 30	PTD	F-232489	979272	
030.109.243J	531 0252 30	PTD	F-232489	979272	
030.109.243K	531 0252 30	PTD	F-232489	979272	
030.145.299C	534 0123 20	PTA	F-235786,01	950452	
030.145.299F	534 0123 20	PTA	F-235786,01	950452	
036.109.243A	531 0317 10	PTD	F-231221		
036.109.243AC	531 0339 10	PTD	F-234203.1		
036.109.243AE	531 0339 10	PTD	F-234203.1		
036.109.243AG	531 0339 10	PTD	F-234203.1		
036.109.243B	531 0317 10	PTD	F-231221		



## INTERCAMBIOS

No. E.O.	No. AS	SIGLAS	NUMERO INA	ATECH / TENDECO / LITENS	DAYCO
----------	--------	--------	------------	--------------------------	-------

VOLKSWAGEN					
036.109.243C	531 0339 10	PTD	F-234203.1		
036.109.243E	531 0317 10	PTD	F-231221		
036.109.243K	531 0339 10	PTD	F-234203.1		
036.109.243K	531 0339 10	PTD	F-234203.1		
036.109.243L	531 0317 10	PTD	F-231221		
036.109.243R	531 0317 10	PTD	F-231221		
036.109.243S	531 0339 10	PTD	F-234203.1		
036.109.244C	532 0167 10	PGD	F-231219		
036.109.244D	532 0167 10	PGD	F-231219		
036109181A	532 0185 10	PGD	F-231220		
037.145.276A	532 0169 10	PGA	F-231224	900085	
037.145.276E	532 0169 10	PGA	F-231224	900085	
037.145.278A	532 0169 10	PGA	F-231224	900085	
037.903.315A	531 0286 30	PTA	F-235781	950404	
037.903.315B	531 0286 30	PTA	F-235781	950404	
037.903025C	535 0012 10	PGL		930003	
037903315C	531 0286 30	PTA	F-235781	950404	
038.109.243N	531 0440 30	PTD		979592	
038.109.244B	532 0111 10	PGD	F-239421		
038.109.244C	532 0111 10	PGD	F-239421		
038.109.244H	532 0111 10	PGD	F-239421		
038.903.018B	535 0012 10	PGL		930003	
038.903.023S	535 0012 10	PGL		930003	
044.145.278AF	532 0150 10	PGA	F-231228	900080	
045 109 243 A	531 0436 20	PTD			
045 109 243 C	531 0436 20	PTD			
051.109.243ABF	531 0083 10	PTD	F-220083.01		
058.109.243 B	531 0333 20	PTD	F-123808		
058.109.244	532 0161 10	PGD	F-225531/F-227242		
058.260.511	531 0309 10	PTA	F-230875	900072	
068.109.243B	531 0079 10	PTD	F-220095.01		
068.109.243C	531 0079 10	PTD	F-220095.01		
068.109.243F	531 0079 10	PTD	F-220095.01		
069.109.243B	532 0051 10	PGD	F-220096.01		
06A.109.479A	531 0203 20	PTD	F-123814		
06A.903.315D	531 0288 30	PTA	F-235782	950414	
06A.903.315E	531 0288 30	PTA	F-235782	950414	
06B.109.243	531 0500 20	PTD	F-125067		
06B.109.243D	531 0500 20	PTD	F-125067		



## INTERCAMBIOS

No. E.O.	No. AS	SIGLAS	NUMERO INA	ATECH / TENDECO / LITENS	DAYCO
----------	--------	--------	------------	--------------------------	-------

### VOLKSWAGEN

06B.109.244	532 0312 20	PGD			
06B.109.477	533 0030 20	THA	F-125068		
06B.903.133	531 0537 30	PTA	F-125046		
074.109.243C	531 0278 30	PTD	F-234393	979479 / 979332	
074.109.243E	531 0278 30	PTD	F-234393	979479 / 979332	
074.109.243H	531 0278 30	PTD	F-234393	979479 / 979332	
074.109.243M	531 0278 30	PTD	F-234393	979479 / 979332	
074.130.195B	531 0276 30	PTD		979278	
074.130.245A	532 0496 10	PGA		979279	
074.145.278C	532 0162 10	PGA	F-231143		
074.145.278E	532 0169 10	PGA	F-231224	900085	
074.145.278F	532 0150 10	PGA	F-231228	900080	
078.109.244H	532 0159 10	PGD			
078.109.487A	533 0037 20	THB	F-125077		
078.903.133AB	531 0490 30	PTA		950440	89336
377.145.299	531 0440 20	PTA		999312	
377.260.229	531 0439 20	PTA		999313	
GY0215980C	532 0263 20	PGA		999003	89181
	532 0494 10	PGA		900125	

### VOLVO

8630590	532 0317 10	PGD	F-124274		
8670484	531 0312 10	PTD	F-233878.1		
9125571	531 0334 10	PTA	F-234055.1		
9135036	531 0090 10	PTD	F-224693		
9440329	531 0312 10	PTD	F-233878.1		
9458470	532 0242 10	PGA	F-233412		
9497331	531 0334 10	PTA	F-234055.1		

## ESPECIFICACIONES

No. AS	No. INA	Dimensiones (mm)			Configuración	No. Ranuras	Material
		d= Int	D= Ext	B= Ancho			
531 0003 10	F-220090.1	10,19	80,00	25,39	Lisa		Termoplastico
531 0004 10	F-220695.1	25,50	75,00	38,00	Lisa		Termoplastico
531 0018 10							
531 0019 10	F-140054	29,00	47,00	53,94	Lisa		Acero
531 0020 10	F-140055	30,00	59,00	54,34	Lisa		Acero
531 0021 10	F-140221	30,00	86,00	49,00	Lisa		Termoplastico
531 0030 10	F-121287.5	22,00	59,00	32,79	Lisa		Acero
531 0047 10	F-122868	33,00	57,00	42,00	Lisa		Acero
531 0054 30	F-232488	25,00	58,00	27,50	Lisa		Acero
531 0063 10	F-220093.1	20,50	72,00	27,50	Lisa		Acero
531 0063 11	F-217668.2C	20,50	72,00	27,50	Lisa		Acero
531 0079 10	F-220095.01	26,50	72,00	34,59	Lisa		Acero
531 0083 10	F-220083.01	26,50	72,00	32,89	Lisa		Acero
531 0090 10	F-224693	27,00	53,00	36,50	Lisa		Acero
531 0095 10		8,00	80,00	21,50	Lisa		Termoplastico
531 0096 10	F-121338.5	24,50	90,00	32,50	Lisa		Acero
531 0101 30	F-232482	19,50	59,00	46,25	Lisa		Acero
531 0118 20					Lisa		Acero
531 0121 20	F-554646		55,00	19,00	Lisa		Acero
531 0123 20	F-124078	19,50	60,00	23,00	Lisa		Acero
531 0131 20	F-123816	27,00	62,00	40,00	Lisa		Acero
531 0132 20	F-125038		70,00	19,00	Lisa		Acero
531 0177 20	F-554652		62,00	36,50	Lisa		Acero
531 0181 20	F-124061		57,00	25,00	Lisa		Acero
531 0193 20					Lisa		Acero
531 0203 20	F-123814	25,00	72,00	27,50	Lisa		Acero
531 0208 20	F-124065	26,00	60,00	31,50	Lisa		Acero
531 0214 20	F-124079		60,00	30,00	Lisa		Acero
531 0241 10	F-122598	26,59	65,00	62,19	Lisa		Acero
531 0251 30	F.232486	8,00	67,00	30,00	Lisa		Termoplastico
531 0252 30	F-232489	23,59	61,69	51,09	Lisa		
531 0258 10	F-122965	24,50	70,00	32,69	Lisa		Acero
531 0265 10	F-123449	24,50	90,00	33,59	Lisa		Acero
531 0267 10	F-231286.03	24,50	70,00	38,64	Lisa		Termoplastico
531 0273 30	F-234394	22,00	59,00	20,00	Lisa		Acero
531 0276 30	F-234395	24,00	66,00	24,39	Lisa		
531 0278 30	F-234393	27,00	73,00	21,50	Lisa		Acero

## ESPECIFICACIONES

No. AS	No. INA	Dimensiones (mm)			Configuración	No. Ranuras	Material
		d= Int	D= Ext	B= Ancho			
531 0280 10	F-233127.1	29,00	60,00	22,50	Lisa		Termoplastico
531 0286 30	F-235781		103,00	40,00			
531 0288 30	F-235782	48,50	70,00	73,00	Lisa		Termoplastico
531 0292 30	F-550492	17,00	76,00	24,00	Lisa		Acero
531 0298 30	F-235783	26,00	70,00	97,00	Lisa		Acero
531 0306 10	F-122748.11	27,00	70,00	62,00	Lisa		Acero
531 0309 10	F-230875	19,00	59,79	42,29	Ranurada	4	Acero
531 0312 10	F-233878.1	27,00	59,00	22,00	Lisa		
531 0314 20	F-123635		53,00	26,00	Lisa		Acero
531 0317 10	F-231221	25,19	60,00	40,50	Lisa		
531 0322 10	F-231107	26,00	70,00	78,00	Lisa		Termoplastico
531 0326 10	F-200017.3	28,00	70,00	49,39	Lisa		Acero
531 0333 20	F-123808	26,00	66,00	39,29	Lisa		
531 0334 10	F-234055.1	24,00	70,00	54,00	Lisa		Termoplastico
531 0339 10	F-234203.1	18,69	60,00	15,89	Lisa		Termoplastico
531 0345 10	F-140931	29,00	60,00	33,29	Lisa		Termoplastico
531 0346 10	F-230207	17,00	70,00	26,00	Lisa		Termoplastico
531 0353 10	F-122649	26,59	65,00	62,19	Lisa		Termoplastico
531 0364 10	F-210240.4	24,50	70,00	15,00	Lisa		Acero
531 0368 10	FC 65251.2	30,19	47,50	38,92	Lisa		Acero
531 0370 10	FC 67992.2	24,50	70,00	15,00	Lisa		Acero
531 0371 10	FC 67992.3		70,00	24,50	Lisa		Acero
531 0380 10	F-234848	31,00	58,00	36,00	Lisa		Acero
531 0409 30	F-550223	32,00	65,50	32,00	Lisa		
531 0410 30	F-237804	33,00	66,00	39,50	Lisa		
531 0427 10	F-123190	25,50	70,00	35,00	Lisa		Acero
531 0429 20		17,00	90,00	30,50	Lisa		
531 0430 10		17,00	90,00	30,00	Lisa		
531 0430 20		17,00	76,00	32,00	Ranurada	7	Termoplastico
531 0431 30		17,00	76,00	30,50	Lisa		
531 0433 20		17,00	90,00	25,50	Lisa		Termoplastico
531 0434 30					Ranurada		Termoplastico
531 0435 30		17,00	90,00	30,50	Lisa		
531 0436 20	F-125060		72,00	25,00	Lisa		
531 0437 30		17,00	76,00	34,00	Lisa		
531 0438 30		17,00	90,00	32,00	Lisa		
531 0439 20	F-125080	29,19	59,89	25,59	Lisa		

## ESPECIFICACIONES

No. AS	No. INA	Dimensiones (mm)			Configuración	No. Ranuras	Material
		d= Int	D= Ext	B= Ancho			
531 0440 20					Lisa		
531 0440 30		8,00	67,00	30,00	Lisa		Acero
531 0441 20		17,00	70,00	25,00	Ranurada	6	Termoplastico
531 0442 30		17,00	90,00	30,50	Lisa		Acero
531 0443 30		17,00	90,00	25,50	Lisa		Termoplastico
531 0444 30		17,00	76,00	30,50	Lisa		Acero
531 0445 20		17,00	90,00	30,50	Lisa		Termoplastico
531 0446 10		17,00	76,00	25,00	Ranurada	6	Termoplastico
531 0446 20		17,00	90,00	22,00	Ranurada		Termoplastico
531 0447 20		17,00	90,00	30,50	Lisa		Termoplastico
531 0448 20					Lisa		Termoplastico
531 0449 20		17,00	90,00	30,50	Lisa		Termoplastico
531 0450 20		17,00	90,00	30,50	Lisa		Termoplastico
531 0451 20		17,00	70,00	25,00	Ranurada	6	Termoplastico
531 0452 20		17,00	76,00	25,00	Ranurada	6	Termoplastico
531 0453 20		17,00	82,00	30,50	Lisa		
531 0454 20		17,00	100,00	28,00	Lisa		
531 0455 20		17,00	82,00	27,00	Ranurada	4	Termoplastico
531 0456 20		17,00	90,00	25,50	Lisa		Termoplastico
531 0457 20		17,00	70,00	25,00	Lisa		Termoplastico
531 0459 20		17,00	76,00	25,00	Ranurada	6	Termoplastico
531 0460 20					Lisa		
531 0461 20		17,00	76,00	30,50	Lisa		Termoplastico
531 0462 20					Lisa		Termoplastico
531 0463 20					Lisa		
531 0478 10	F-232829.4	31,00	73,00	24,19	Lisa		
531 0479 10	F-125051		78,00	25,00	Lisa		
531 0487 30		17,00	90,00	26,00	Lisa		Termoplastico
531 0488 30	F-550488	30,00	68,00	72,00			
531 0490 30		17,00	76,00	25,00	Lisa		Acero
531 0500 20	F-125067				Lisa		
531 0518 30	F-232481.1	22,00	59,00	33,00	Lisa		Acero
531 0521 30		17,00	82,00	27,00	Lisa		Acero
531 0531 20	F-125066				Lisa		Acero
531 0537 30	F-125046				Lisa		
531 0541 10	F-125054		103,00	27,00	Ranurada		
531 0546 10	F-125081	29,00	61,79	28,00	Lisa		

## ESPECIFICACIONES

No. AS	No. INA	Dimensiones (mm)			Configuración	No. Ranuras	Material
		d= Int	D= Ext	B= Ancho			
531 0560 00		17,00	76,00	25,00	Ranurada	6	Termoplastico
531 0563 00							
531 0566 40			67,00	40,50	Lisa		Acero
531 0567 00		8,50	70,00	33,00	Lisa		Acero
531 0568 00		17,00	70,00	19,00	Lisa		Termoplastico
531 0585 20					Lisa		Acero
531 0586 10	F-550126	26,59	60,00	37,09	Lisa		
531 0647 20					Lisa		Acero
531 0793 10		17,00	76,00	32,00	Ranurada	7	Termoplastico
531 0794 10		17,00	90,00	25,50	Lisa		Termoplastico
531 0795 10		17,00	76,00	22,00	Lisa		Termoplastico
531 0796 10		17,00	90,00	30,00	Lisa		Acero
531 0797 10		17,00	76,00	38,00	Ranurada	8	Acero
531 0798 10		17,00	70,00	29,50	Lisa		Acero
531 0799 10		17,00	76,00	29,00	Ranurada	6	Acero
531 0800 10		17,00	90,00	30,50	Lisa		Acero
531 1133 71	F-113371	22,00	59,00	27,50	Lisa		Acero
531 2201 10	F-236298	26,00	70,00	20,00	Lisa		
532 0001 10	F-220259.2	8,19	70,00	24,50	Lisa		Termoplastico
532 0016 10	F-140222	28,50	60,00	30,00	Lisa		
532 0020 10	F-122124	34,00	60,00	42,00	Lisa		
532 0028 10	F-220280	8,19	64,00	35,50	Ranurada	8	Termoplastico
532 0030 10	F-220279	33,59	70,00	37,60	Ranurada		
532 0031 10	F-220278	8,00	80,00	32,00	Lisa		Termoplastico
532 0033 10	F-224971.01	23,00	62,69	36,50	Lisa		Termoplastico
532 0034 10	F-224967	23,00	52,50	25,00	Lisa		
532 0039 10	F-224964	27,00	52,50	29,39	Lisa		
532 0040 10	F-224966	27,00	62,69	29,39	Lisa		Termoplastico
532 0051 10	F-220096.01	27,39	74,00	35,19	Lisa		Acero
532 0059 10	F-123780	23,00	70,00	26,00	Lisa		Acero
532 0066 10		8,19	85,00	25,00	Lisa		Termoplastico
532 0067 10	F-214797.4	25,25	78,00	27,19	Lisa		Termoplastico
532 0074 20					Lisa		Acero
532 0087 10	F-231413	27,00	54,00	29,39	Lisa		
532 0092 20	F-554651		62,00	36,50	Lisa		Acero
532 0093 10		29,00	48,00	29,50	Lisa		
532 0109 10	F-224134	22,59	75,00	30,44	Ranurada		Termoplastico

## ESPECIFICACIONES

No. AS	No. INA	Dimensiones (mm)			Configuración	No. Ranuras	Material
		d= Int	D= Ext	B= Ancho			
532 0111 10	F-239421	29,00	80,00	47,19	Lisa		Acero
532 0120 10	F-231098	29,00	57,00	50,39	Lisa		Termoplastico
532 0123 10	F-122966	24,50	70,00	33,69	Lisa		
532 0124 10	F-123761	25,00	69,69	32,39	Lisa		Termoplastico
532 0132 20							
532 0138 10	F-123749		25,00	90,50	Lisa		Termoplastico
532 0139 10	F-123760	25,00	90,50	36,00	Lisa		Termoplastico
532 0142 10	F-122574	32,00	57,00	40,69	Lisa		
532 0143 10	F-122530.12		26,00	50,00	Lisa		Acero
532 0150 10	F-231228	22,59	76,00	29,79	Ranurada	6	Termoplastico
532 0151 10	F-231137	29,00	70,00	47,84	Lisa		
532 0152 10	F-231338	29,00	47,00	51,50	Lisa		
532 0159 10	F-231231	31,00	59,00	35,59	Lisa		
532 0160 10	F-231069	17,00	63,50	26,50	Ranurada	6	Termoplastico
532 0161 10	F-225531/F-227242		28,50	29,00	Lisa		
532 0162 10	F-231143	25,00	78,00	25,50	Lisa		
532 0167 10	F-231219	21,69	56,00	78,69	Lisa		
532 0169 10	F-231224	25,00	90,00	29,79	Lisa		Termoplastico
532 0180 20	F-124054	23,00	52,50	38,19	Lisa		
532 0185 10	F-231220	29,00	28,50	42,50	Lisa		
532 0187 10	F-233879	60,00	29,00	62,84	Lisa		
532 0209 10	F-110628.3	30,39	65,00	35,33	Lisa		Acero
532 0221 10	F-123778		54,00	32,00	Lisa		
532 0227 10	FC 68768.3	35,00	62,00	10,00	Lisa		Acero
532 0229 10	F-110627.4	23,00	80,00	30,69	Lisa		
532 0233 10	F-234843		64,00	30,00	Ranurada		
532 0234 10	F-234842		54,00	30,00	Lisa		Acero
532 0242 10	F-233412	26,39	119,00	27,69	Ranurada		
532 0243 10	F-124059		60,19	25,50	Lisa		Termoplastico
532 0254 10	F-236653		70,00	28,69	Lisa		Termoplastico
532 0261 10		17,00	90,00	16,50	Ranurada	3/8"	Acero
532 0261 20			95,00	12,00	Ranurada	3/8"	Acero
532 0262 20		17,00	90,00	22,00	Ranurada	4	Termoplastico
532 0263 20		17,00	76,00	30,50	Lisa		
532 0264 20		17,00	82,00	25,00	Lisa		Termoplastico
532 0265 20		17,00	76,00	30,50	Lisa		Acero
532 0266 20		17,00	70,00	26,00	Lisa		Termoplastico

## ESPECIFICACIONES

No. AS	No. INA	Dimensiones (mm)			Configuración	No. Ranuras	Material
		d= Int	D= Ext	B= Ancho			
532 0267 20		17,00	76,00	26,00	Lisa		Termoplastico
532 0268 20		17,00	76,00	25,00	Lisa		Termoplastico
532 0269 20		17,00	70,00	25,00	Ranurada	6	Termoplastico
532 0270 20		17,00	76,00	25,00	Ranurada	6	Termoplastico
532 0271 20							
532 0272 20		17,00	76,00	32,00	Ranurada	7	Termoplastico
532 0273 20		17,00	90,00	26,29	Ranurada	6	Termoplastico
532 0274 20		17,00	90,00	31,00	Lisa		Termoplastico
532 0275 20		17,00	127,00	26,00	Ranurada	6	Termoplastico
532 0276 20		17,00	109,00	26,29	Ranurada	6	Termoplastico
532 0276 21							
532 0277 20		17,00	76,00	34,00	Lisa		Acero
532 0278 20		17,00	94,00	19,00	Ranurada		Acero
532 0279 20		17,00	70,00	20,50	Ranurada	4	Acero
532 0280 20		17,00	71,00	18,00	Ranurada	1/2"	Acero
532 0285 20		12,00	123,00	18,50	Ranurada	1/2"	Acero
532 0304 10	F-238472	26,00	54,00	26,00	Lisa		
532 0308 10	F-123781		54,00	32,00	Lisa		
532 0309 10	F-220277	25,00	80,00	29,75	Lisa		Termoplastico
532 0312 20			28,50	27,00	Lisa		Acero
532 0317 10	F-124274	27,00	53,00	35,50	Lisa		Acero
532 0320 10	F-123934.5	30,00	60,00	55,29	Lisa		
532 0373 20					Lisa		Acero
532 0446 10	F-239960	32,00	54,00	32,00	Lisa		
532 0484 10		17,00	100,00	30,50			
532 0485 10		17,00	82,00	25,00			
532 0486 10		17,00	90,00	37,50	Lisa		Acero
532 0487 10		17,00	90,00	30,00	Lisa		Acero
532 0488 10			94,00	19,00	Ranurada	1/2"	Acero
532 0489 10		15,00	70,00	27,00	Lisa		Termoplastico
532 0490 10			76,00	31,00	Lisa		Acero
532 0491 10		12,00	70,00	26,00	Ranurada	6	Acero
532 0492 10		17,00	76,29	29,50	Lisa		Acero
532 0493 10		17,00	76,00	30,00	Lisa		Acero
532 0494 10		17,00	70,00	25,00			
532 0495 10		12,00	127,00	29,00	Ranurada	6	Termoplastico
532 0496 10							

## ESPECIFICACIONES

No. AS	No. INA	Dimensiones (mm)			Configuración	No. Ranuras	Material
		d= Int	D= Ext	B= Ancho			
532 0497 10		12,00	91,00	17,50	Ranurada		Acero
532 0498 10							
532 0499 10		12,00	107,00	36,00	Ranurada	1/2"	Acero
532 0600 20					Lisa		Termoplastico
532 0601 20					Lisa		Termoplastico
532 0602 20					Lisa		Acero
532 0603 20	F-125068	17,00	70,00	25,00	Lisa		Termoplastico
533 0001 10	F-221646-100	36,00	95,00	15,00			
533 0003 10	F-223369-100	37,00	95,00	15,00			
533 0007 10	F-227252-100						
533 0013 10	F-231285-100	36,00	95,00	15,00			
533 0014 10		36,00	95,00	15,00			
533 0015 10		17,00	70,00	26,00	Lisa		Termoplastico
533 0017 10	F-231071	28,00	70,00	54,79	Lisa		
533 0018 10	F-231072		31,75	112,00			
533 0023 10		17,00	70,00	32,00	Lisa		Acero
533 0030 20	F-125068				Lisa		Acero
533 0037 20	F-125077						
533 0072 20	F-123746	25,00	90,00	23,89	Lisa		
533 0086 30							
534 0003 10	F-231286	26,00	70,00	15,00	Lisa		
534 0004 10	F-231285	28,00	70,00	15,00	Lisa		
534 0006 10		8,19	70,00	25,50	Lisa		Termoplastico
534 0008 10	F-231289	24,50	70,00	15,00	Lisa		
534 0009 10	F-231288	24,50	70,00	15,00			
534 0016 10	F-226239.9	26,00	70,00	15,00	Lisa		
534 0022 10	F-125050	25,00	65,00	44,00	Lisa		
534 0036 10	F-123797				Lisa		
534 0037 10	F-123792	26,59	65,00	118,89	Lisa		
534 0123 20	F-235786,01	26,00	70,00	101,00	Lisa		
534 0124 30		17,00	82,00	27,00	Lisa		Acero
534 0125 30		17,00	70,00	25,00			
534 0126 30	F-550493	29,00	62,00	14,69			
534 0127 30		17,00	76,00	28,00	Lisa		Acero
534 0128 30	F-125047				Ranurada		Termoplastico
534 0130 20	F-125056	17,00	70,00	25,00	Ranurada	6	Termoplastico
534 0190 10		17,00	82,00	30,50	Lisa		Acero



## ESPECIFICACIONES

No. AS	No. INA	Dimensiones (mm)			Configuración	No. Ranuras	Material
		d= Int	D= Ext	B= Ancho			
534 0191 10		17,00	76,00	30,50	Lisa		Acero
534 0193 10		17,00	90,00	37,50	Lisa		Acero
534 0194 10		17,00	100,00	30,50	Lisa		Acero
534 0195 10		17,00	102,00	26,00	Lisa		Acero
534 0196 10		17,00	70,00	25,00	Lisa		Termoplastico
534 0197 10		17,00	90,00	29,50	Ranurada	6	Acero
534 0198 10		17,00	70,00	25,00	Ranurada	6	Termoplastico
534 0199 10		17,00	70,00	25,00	Ranurada	6	Termoplastico
534 0200 10		17,00	76,00	30,50	Lisa		Acero
534 0201 10		17,00	100,00	30,50	Lisa		Acero
534 0202 10		17,00	76,00	25,00	Lisa		Termoplastico
534 0203 10		17,00	76,00	25,00	Lisa		Termoplastico
534 0204 10		17,00	90,00	30,00	Lisa		Acero
534 0205 10		17,00	98,00	27,00	Ranurada	6	Acero
534 0206 10		17,00	70,00	25,00	Lisa		Termoplastico
534 0207 10		17,00	76,00	30,50	Lisa		Acero
534 0208 10		17,00	76,00	30,50	Lisa		Acero
534 0209 10		17,00	70,00	25,00	Lisa		Acero
534 0210 10		17,00	70,00	25,00	Ranurada	6	Termoplastico
534 0211 10		17,00	76,00	30,50	Lisa		Acero
534 0212 10		17,00	76,00	30,50	Lisa		Acero
534 0213 10		17,00	76,00	22,00	Lisa		Termoplastico
534 0214 10		17,00	76,00	30,50	Lisa		Acero
534 0215 10		17,00	76,50	37,50	Lisa		Acero
534 0216 10		17,00	82,50	31,00	Lisa		Acero
534 0217 10		17,00	70,00	26,00	Lisa		Termoplastico
534 0218 10		17,00	76,00	38,00	Ranurada	8	Acero
534 0219 10		17,00	76,29	29,50	Lisa		Acero
534 0220 10		17,00	76,00	30,00	Ranurada	6	Acero
534 0221 10		17,00	76,00	34,00	Lisa		Termoplastico
534 0222 10		17,00	76,00	34,00	Lisa		Termoplastico
534 0223 10		17,00	70,00	34,00	Lisa		Termoplastico
534 0224 10		17,00	102,50	34,50	Lisa		Acero
534 0225 10		17,00	76,00	30,50			
534 0226 10		12,00	60,00	21,00	Lisa		Acero
534 0227 10		17,00	65,00	20,00	Lisa		Termoplastico
534 0228 10		17,00	76,00	30,50	Lisa		Acero



## ESPECIFICACIONES

No. AS	No. INA	Dimensiones (mm)			Configuración	No. Ranuras	Material
		d= Int	D= Ext	B= Ancho			
534 0229 10		17,00	70,00	25,00	Ranurada	6	Termoplastico
534 0230 10		17,00	70,00	25,00	Lisa		
534 0231 10		17,00	70,00	25,00	Ranurada	6	Termoplastico
534 0232 10		17,00	76,00	31,00	Lisa		Acero
534 0233 10		17,00	90,00	30,50	Lisa		Acero
534 0234 10		17,00	90,00	29,00	Lisa		Acero
534 0235 10		17,00	85,00	31,00	Lisa		Acero
534 0236 10		17,00	76,00	25,00	Ranurada	6	Termoplastico
534 0237 10		17,00	52,00	15,00		3	Termoplastico
534 0238 10		8,00	52,00	13,00		3	Termoplastico
535 0001 10	F-225355.7	17,00	55,00	40,64	Ranurada		Acero
535 0012 10		14,50	52,50	35,50	Ranurada		Acero
535 0025 10		14,50	56,00	42,50	Ranurada		Acero
535 0045 10	F-232030.5	17,00	50,00	36,29	Ranurada		Acero

## NOTAS

---

---

---

---

---

---

---

---

---

---

---

---

---

---

---

---

---

---

---

---

---

---

---

---

---

---

---

---

---

---



**NOTAS**



---

---

---

---

---

---

---

---

---

---

---

---

---

---

---

---

---

---

---

---

---

---

---

---

---

---

---

---

---

A series of horizontal lines for taking notes.







# Sistemas de distribución con banda dentada para circuito primario (distribución)



Los componentes de distribución en automóviles con banda tienen dos funciones:

El control de las válvulas –conocido como circuito primario– es efectuado a través de una banda dentada que transmite de forma precisa el movimiento giratorio del cigüeñal al árbol de levas en una relación de 2:1, asegurando que el movimiento de los pistones y el tiempo de apertura y cierre de las válvulas estén perfectamente sincronizados.

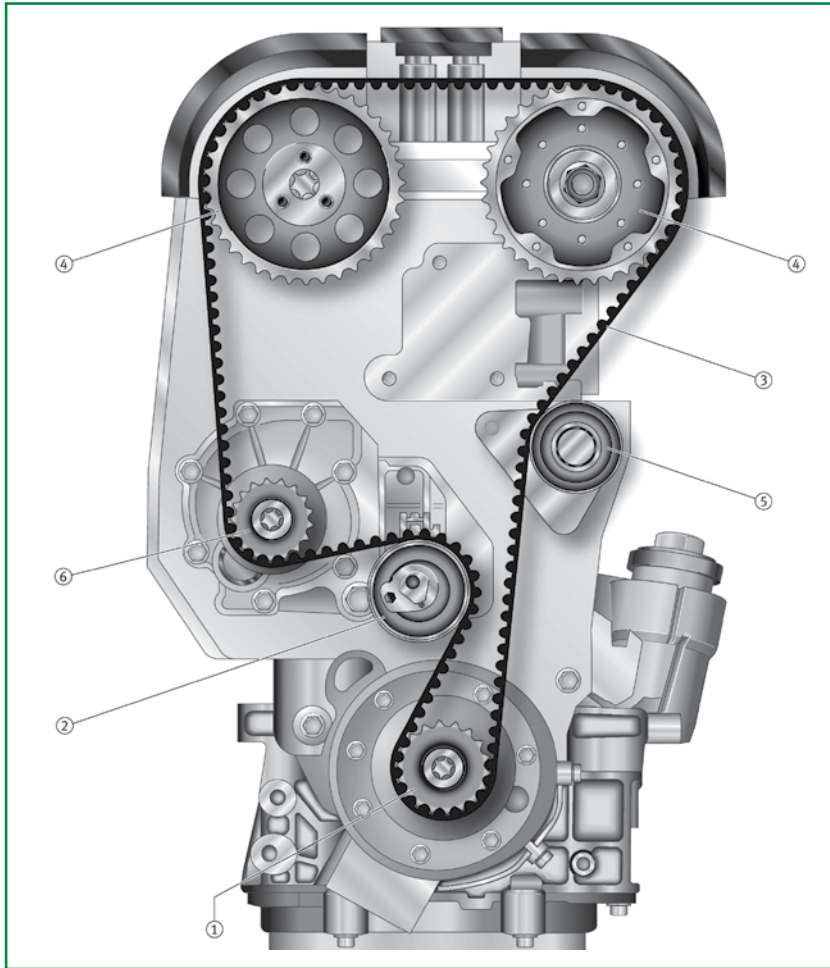

- 1) Engrane del cigüeñal
- 2) Tensor
- 3) Banda dentada
- 4) Engranes de los árboles de levas
- 5) Poleas guía (locas)
- 6) Bomba de agua

## Funciones del sistema distribución por banda dentada

- Conectan el cigüeñal con el (los) árbol(es) de levas del motor de combustión interna.
- Pueden accionar la bomba de dirección y bomba de agua.
- Pueden impulsar un eje intermedio de balance.
- Pueden estar configurados en uno, dos o más sistemas separados.

## Ventajas del sistema de distribución por banda dentada:

- Alta precisión en el control del tren valvular durante toda la vida del motor.
- Mayor vida útil.
- Bajo nivel de ruido en su operación.
- Fácil instalación, no requiere de mantenimiento frecuente, bajo costo.
- No requiere de lubricación.
- Diseño compacto.
- Fricción mínima.
- Alto rendimiento.

## Componentes del sistema de circuito secundario (accesorio)



Los sistemas de accionamiento del circuito secundario (accesorio) pueden estar compuestos de uno, dos o más sistemas separados, normalmente están diseñados como circuito de una banda serpentin.

El sistema es accionado por una banda Poly-V (f) cuya tensión se ajusta con precisión a las cargas requeridas, a través de sistemas de tensión mecánica o hidráulica (g).

Las poleas guía (locas) son utilizadas para mantener la ruta correcta de los accesorios del motor como estabilizadores para eliminar vibraciones cíclicas de la banda.

Las bandas Poly-V están diseñadas para transmitir el torque del motor hasta los 350 Nm (258 lb-pie) en automóviles modernos, sin perder la tracción desde el cigüeñal (a) hacia los demás accesorios como:

- b) Alternador.
- c) Bomba de dirección hidráulica.
- d) Bomba de agua.
- e) Compresor de aire acondicionado.

y otros componentes como el ventilador o el súper cargador mecánico.

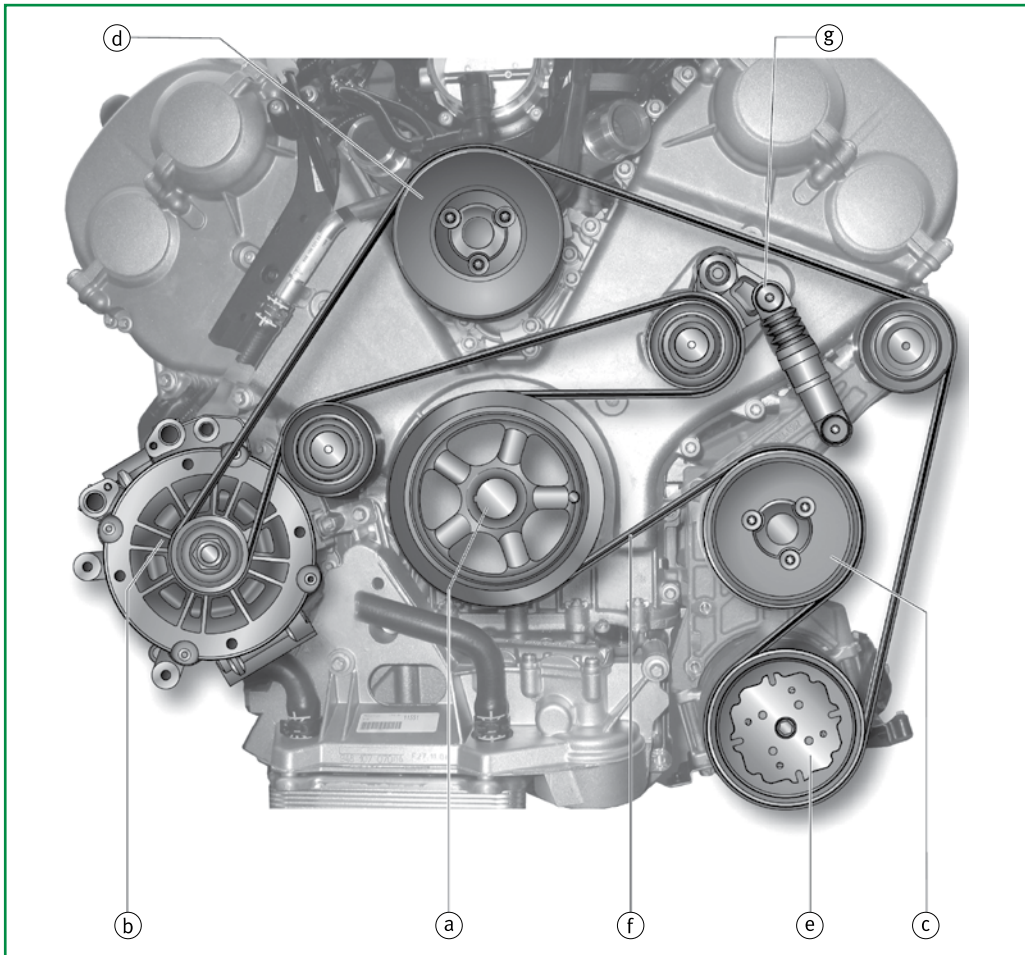

### Ventajas de los sistemas de impulso de los componentes del circuito secundario (accesorio) modernos:

- Reduce la posibilidad de patinado durante el accionamiento de los accesorios.
- Mayor vida útil (160,000 km o más).
- Reducción de la emisión de ruidos y vibraciones durante la operación.
- Requiere de poco espacio de instalación.
- Mantenimiento sencillo.

# Sistemas de distribución con banda dentada para circuito primario (distribución)



Los componentes de distribución en automóviles con banda tienen dos funciones:

El control de las válvulas –conocido como circuito primario– es efectuado a través de una banda dentada que transmite de forma precisa el movimiento giratorio del cigüeñal al árbol de levas en una relación de 2:1, asegurando que el movimiento de los pistones y el tiempo de apertura y cierre de las válvulas estén perfectamente sincronizados.

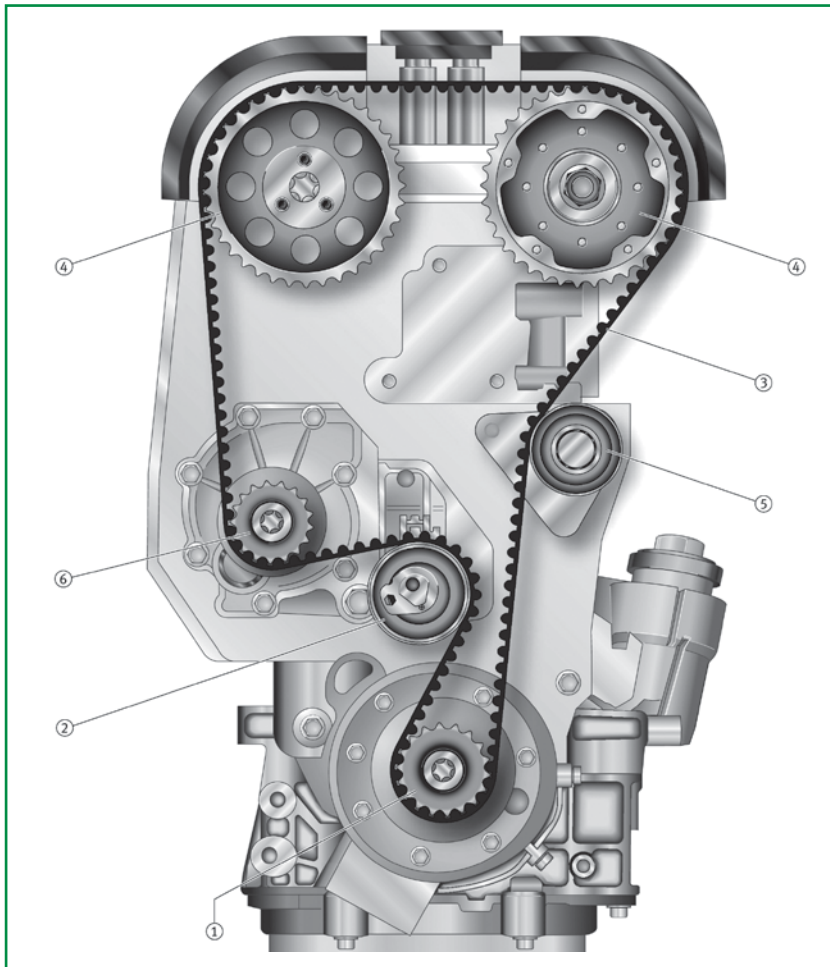

- 1) Engrane del cigüeñal
- 2) Tensor
- 3) Banda dentada
- 4) Engranes de los árboles de levas
- 5) Poleas guía (locas)
- 6) Bomba de agua

## Funciones del sistema distribución por banda dentada

- Conectan el cigüeñal con el (los) árbol(es) de levas del motor de combustión interna.
- Pueden accionar la bomba de dirección y bomba de agua.
- Pueden impulsar un eje intermedio de balance.
- Pueden estar configurados en uno, dos o más sistemas separados.

## Ventajas del sistema de distribución por banda dentada:

- Alta precisión en el control del tren valvular durante toda la vida del motor.
- Mayor vida útil.
- Bajo nivel de ruido en su operación.
- Fácil instalación, no requiere de mantenimiento frecuente, bajo costo.
- No requiere de lubricación.
- Diseño compacto.
- Fricción mínima.
- Alto rendimiento.

## Componentes del sistema de circuito secundario (accesorio)



Los sistemas de accionamiento del circuito secundario (accesorio) pueden estar compuestos de uno, dos o más sistemas separados, normalmente están diseñados como circuito de una banda serpentin.

El sistema es accionado por una banda Poly-V (f) cuya tensión se ajusta con precisión a las cargas requeridas, a través de sistemas de tensión mecánica o hidráulica (g).

Las poleas guía (locas) son utilizadas para mantener la ruta correcta de los accesorios del motor como estabilizadores para eliminar vibraciones cíclicas de la banda.

Las bandas Poly-V están diseñadas para transmitir el torque del motor hasta los 350 Nm (258 lb-pie) en automóviles modernos, sin perder la tracción desde el cigüeñal (a) hacia los demás accesorios como:

- b) Alternador.
- c) Bomba de dirección hidráulica.
- d) Bomba de agua.
- e) Compresor de aire acondicionado.

y otros componentes como el ventilador o el súper cargador mecánico.

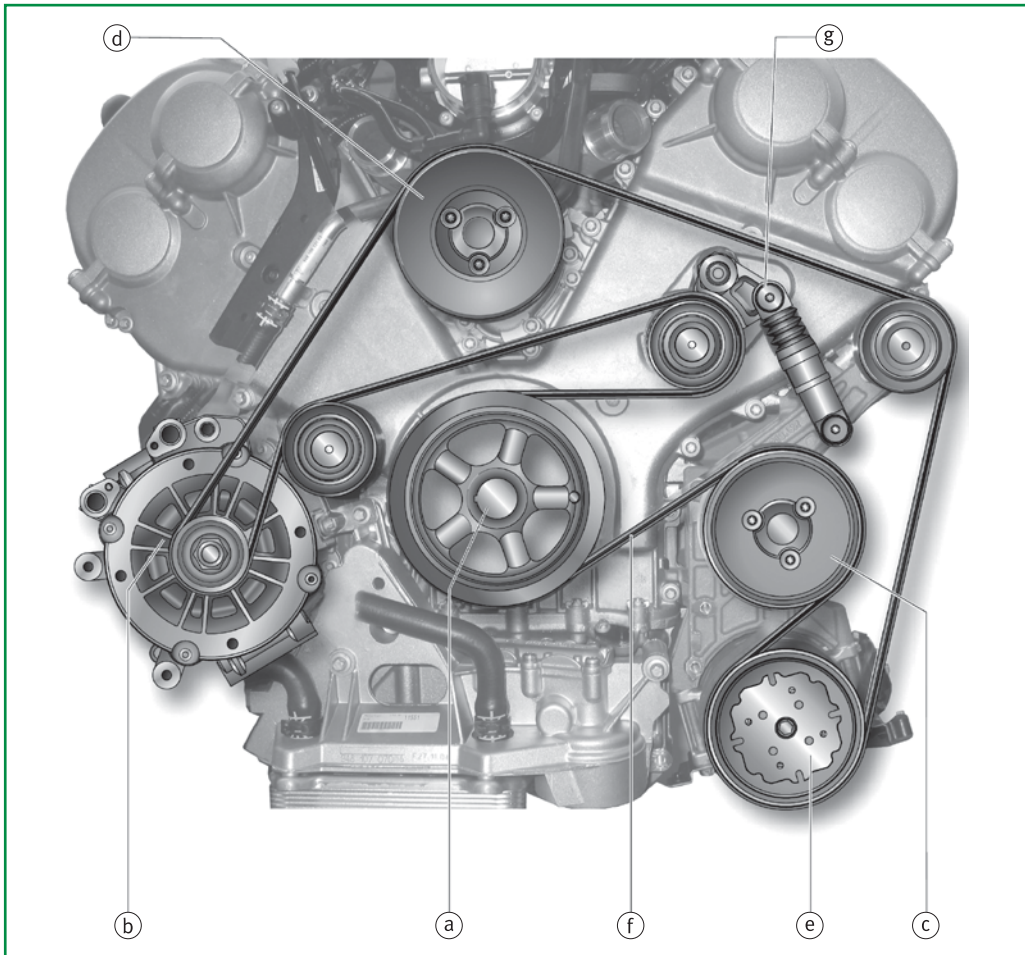

### Ventajas de los sistemas de impulso de los componentes del circuito secundario (accesorio) modernos:

- Reduce la posibilidad de patinado durante el accionamiento de los accesorios.
- Mayor vida útil (160,000 km o más).
- Reducción de la emisión de ruidos y vibraciones durante la operación.
- Requiere de poco espacio de instalación.
- Mantenimiento sencillo.

## Importante:

**Considere siempre los intervalos de inspección y reemplazo de los componentes del circuito primario y secundario.**

### Circuito primario (distribución) – puntos de inspección

1. Inspeccione las condiciones de la banda dentada.
2. ¿Cuándo y en qué kilometraje del vehículo se cambió por última vez la banda dentada?
3. ¿Existe un registro de las últimas inspecciones? ¿Se le ha dado un mantenimiento regular al vehículo?
4. ¿El vehículo es utilizado bajo condiciones extremas que justifiquen acortar los intervalos de recambio?
5. ¿Están en buen estado los demás accesorios que son accionados por la banda? por ejemplo: árbol de levas, bomba de agua, bomba de dirección hidráulica, etc. ¿Estos emiten ruidos extraños?
6. Reajuste –para el caso de tensores rígidos– con un medidor de tensión. Verifique que la tensión esté correcta.
7. Inspeccione que las poleas de poliamida no muestren señales de desgaste.
8. Verifique que los sellos de los rodamientos estén intactos.
9. Asegúrese que los componentes no muestren señales de corrosión.
10. Si las condiciones de la banda son satisfactorias se puede descartar una posible falla y programar el reemplazo hasta la siguiente inspección.

#### Nota:

La falla de la banda de distribución puede ocasionar considerables daños al motor. Los costos de reemplazar a tiempo la banda son mucho más bajos que los costos de reparación de un motor dañado.

Es importante el asegurarse de las condiciones de la banda. En caso de duda se debe recomendar al cliente el reemplazo.

### Circuito primario – posibles fallas

- La tensión de la banda es demasiado alta o está floja.
- Impurezas en el sistema tensor.
- Desgaste en los costados de la banda.
- Desgaste de los dientes de la banda.
- Ruidos por falta de lubricación en los rodamientos.
- Reducción de la tolerancia del rodamiento a causa de la deformación de la pista interna.
  - Torque de apriete incorrecto.
- Daños en las superficies de las poleas.
- Lubricante del rodamiento degradado.

### Circuito secundario (accesorio) – lista de inspección

1. Revisar las condiciones de la banda.
2. Revisar el ajuste de los tensores automáticos.
3. En tensores rígidos, en caso de ser necesario, reajustar la banda y medir nuevamente la tensión.
4. Revisar las condiciones de los perfiles de las poleas “tipo carrete”.
5. Asegúrese de usar las tapas protectoras.
6. En el caso de los tensores hidráulicos, revisar el estado de las tuercas de sujeción y asegurarse que no existan fugas de aceite en el retén.
7. Revisar que la polea gire sin obstrucciones.
8. Inspeccionar que ninguno de los componentes presenten corrosión.

### Circuito secundario – posibles fallas

- La tensión de la banda es demasiado alta o está floja.
- Partículas contaminadas en el mecanismo tensor.
- Desgaste en la banda Poly-V.
- Fisuras en los costados de la banda.
- Ruidos por resequeidad en los sellos del rodamiento.
- Pérdida de lubricante del rodamiento.
  - Falta de la tapa protectora.
- Daños en el tensor hidráulico.
  - Pérdida de lubricante del tensor.
- Polea de “giro libre” de alternador dañada.
  - Patinado de la banda Poly-V
- Polea guía dañada
  - Chicoteo de la banda.

**LuK Clutches**  
Automóviles  
y Carga Ligera



2007/2008 

**Sistemas Hidráulicos**





2007/2008 

**Poleas y Tensores**  
SET de Distribución  
KIT de Distribución





2007/2008 

**Mazas y Rodamientos de Rueda**

2007/2008 

**Rodamientos de Rueda**

2007/2008 

**Rodamientos en General**





2007/2008 

**2007**

**BRAKE PARTS**

Partes para sistema de frenos

**AUTOMÓVILES Y CAMIONETAS**

 **RUVILLE** AFTERMARKET SERVICE 

**2007**

**BRAKE PARTS**

Blecks de Freno





**SERVICIO PESADO**

 **RUVILLE** AFTERMARKET SERVICE 



**2007**

**DRIVE TRAIN PARTS**

Juntas Homocinéticas

**AUTOMÓVILES Y CAMIONETAS**

 **RUVILLE** AFTERMARKET SERVICE 

LuK AFTERMARKET SERVICE, S.A. de C.V.  
Av. Henry Ford No. 145, Col. Bondojoito, C.P. 07850 México D.F.  
Tel.: (55) 5062 6010 al 29, 5537 4242 al 45 Fax: (55) 5517 0906  
Servicio Técnico: 01 (800) 22 550 00  
servicio.tecnico@schaeffler.com  
**SCHAEFFLER GROUP**  
AUTOMOTIVE

**AFTERMARKET SERVICE**

